

دفترچه راهنمای "اینورتر" ( 0.75 ~ 2.2 KW )  
INVOTER



گروه فنی مهندسی SMARTERCO & INVOTER  
مشهد- پارک علم و فناوری خراسان رضوی

[WWW.SMARTERCO.IR](http://WWW.SMARTERCO.IR)

## فهرست مطالب

خریدار گرامی.....	۳
ظاهر دستگاه.....	۴
ابعاد.....	۵
کاربردها.....	۶
موارد ایمنی و حفاظتی.....	۶
کنترلهای قبل از نصب.....	۶
نصب.....	۷
سیم کشی.....	۸
نگهداری.....	۹
شرح مشخصات کلی درایو INVOOTER.....	۱۰
ویژگیهای فنی.....	۱۰
تنظیم پارامترها.....	۱۲
لیست پارامترهای عملکرد "اینورتر".....	۱
اتصالات الکتریکی.....	۳۵
شرح ترمینالهای دستگاه.....	۳۵
اتصال "اینورتر" به مدار الکتریکی.....	۳۷
جداول توضیحات.....	۳۹
روشهای کنترل سرعت توسط "اینورتر".....	۱۰۰
خطاها.....	۱۰۳
ترمینالها.....	۱۰۴
یادداشت.....	۱۰۶

## خریدار گرامی

با سلام و عرض احترام،

ضمن تشکر از انتخاب دقیق و هوشمندانه شما در مورد استفاده از دستگاه "اینورتر" و ارج نهادن به حسن نظر شما در بهره‌گیری از محصولات تولید شده در داخل کشور عزیزمان ایران، توجه شما را به نکاتی چند در جهت شناخت بهتر مشخصات و توانایی‌های این دستگاه و بهره‌گیری کامل از کلیه کارایی‌های آن جلب می‌نمایم؛ اطلاع هر چه بیشتر و دقیق‌تر شما از خصوصیات دستگاه موجب راه‌اندازی سریع‌تر آن و مواجهه شدن کمتر با اشکالات احتمالی خواهد شد.

دستگاهی که هم‌اکنون در اختیار شما قرار دارد، پس از طی مراحل متعدد اصلاح و بهینه‌سازی و با استفاده از بهترین نوع قطعات موجود ساخته شده، و کلیه اجزای داخلی آن تحت نظارت دقیق واحد کنترل کیفیت؛ مراحل مختلف ساخت و مونتاژ را طی نموده است. با توجه به پیچیدگی نسبی و داشتن امکانات متعدد، داشتن اطلاعات کافی از نحوه ایجاد ارتباطات و اتصالات دستگاه و آگاهی از چگونگی تنظیم آن برای مراحل نصب و راه‌اندازی لازم و حیاتی می‌باشد. عدم برخورداری از دانش کافی درباره دستگاه و اتصال یا تنظیم نامناسب آن، می‌تواند آسیب جدی به دستگاه "اینورتر" و احیاناً افراد یا دستگاه‌های مرتبط با آن منجر گردد. به همین دلیل، سازندگان این دستگاه هیچگونه مسؤولیتی در قبال استفاده ناصحیح از دستگاه و آسیب‌های احتمالی ناشی از آن برعهده نخواهد گرفت.

به دلایل فوق‌الذکر خواهشمندیم قبل از هرگونه استفاده از دستگاه، کلیه موارد و توضیحات ذکر شده در این دستورالعمل را به دقت مطالعه نمایید. در صورت وجود هرگونه سؤال یا نکته مبهم، لطفاً با نزدیک‌ترین نمایندگی فروش (بخش خدمات پس از فروش) تماس حاصل فرمایید. با امید به این که بتوانیم خدمت کوچک دیگری در راستای اعتلای صنعت کشور، رضایت صنعتگران پر تلاش و مصرف‌کنندگان محترم انجام دهیم. در این راستا هرگونه انتقاد، نظر یا پیشنهاد شما را صمیمانه پذیرفته و در ارائه محصولات کامل‌تر و رفع نواقص موجود به کار خواهیم گرفت.

## ظاهر دستگاه:



ابعاد:



## کاربردها

- از دستگاه "اینورتر" می توان برای کاربردهای متنوعی استفاده نمود. چند نمونه از کاربردهای این دستگاه عبارتند از:
- ماشین سازها ( لباسشویی و ...)
  - خطوط تولید کاغذ و مقوا
  - تزریق پلاستیک و آلومینیوم
  - سنگبری
  - تولید سفال و آجر
  - صنایع نساجی
  - کنترل دبی پمپها و فنها
  - جوش و برش اتوماتیک
  - ماشینهای مته زنی، قلاویز کاری و ماشینهای ابزار CNC
  - ماشینهای برش الماسه
  - کنترل توان حرارتی مشعلهای بزرگ
  - کارخانه های کاشی و سرامیک

## موارد ایمنی و حفاظتی

توصیه می شود که قبل از نصب دستگاه، موارد ذیل را به دقت مطالعه نموده و در هنگام نصب و پس از آن و هنگام استفاده از دستگاه رعایت نمایید.

## کنترل های قبل از نصب:

- بررسی وضع ظاهری دستگاه از لحاظ سالم بودن بدنه و ترمینالها و عدم وجود آثار ضربه
  - در صورت وجود موارد مشکوک، سریعاً با شرکت تماس حاصل نمایید.
- ⚠ سازنده هیچگونه مسؤلیتی در قبال آسیبهای وارده در هنگام حمل، نگهداری در انبار یا باز کردن جعبه دستگاه بر عهده ندارد.



### نصب:

- دستگاه را به صورت مستقیم یا از کنار بر یک سطح محکم، بدون لرزش و غیر قابل اشتعال نصب کنید.
- فضایی معادل حداقل ۴ سانتیمتر، برای ورود هوای فن در نظر گرفته و به همین میزان، دستگاه را از سطح پشتی فاصله دهید.
- از ریختن یا قراردادن اجسام خارجی مثل خرده سیم، براده فلزات و مواد آتش گیر در داخل یا اطراف دستگاه خودداری نمایید.
- دستگاه را در محفظه‌ای با تهویه مناسب، دمای بین ۰ تا ۴۰ درجه سانتیگراد، رطوبت کمتر از ۸۰٪ نصب کنید.
- دور از تابش مستقیم آفتاب، عاری از مواد و گازهای خورنده یا قابل اشتعال و با حداقل گرد و غبار نصب کنید.
- دستگاه را با حداقل فاصله ممکن از الکتروموتور نصب کنید.
- حداقل فضای لازم در طرفین دستگاه برابر ۱۰ سانتیمتر و در بالا و پایین برابر ۲۰ سانتیمتر می باشد.

- مناسب نبودن فضای مناسب باعث اختلال در تهویه دستگاه، گرم شدن بیش از حد و در نهایت توقف کارکرد آن خواهد شد.



⚠ نکته: در صورتی که بیش از یک دستگاه "اینورتر" در محل نصب وجود داشته باشد، فاصله عمودی لازم بین آنها بیشتر بوده و تا جایی که ممکن است بایستی از نصب آنها در امتداد عمودی یکدیگر و با فاصله کم خودداری نمود.

### سیم کشی

- سیم کشی دستگاه باید توسط پرسنل مجرب و آشنا به دستگاه‌های مشابه و با رعایت کلیه موارد ایمنی انجام شود. در هنگام سیم کشی موارد ذیل را رعایت نمایید.
- بدنه دستگاه باید به سیستم ارت مناسب متصل گردد.
- قبل از هر نوع سیم کشی از قطع بودن برق اصلی اطمینان حاصل نمایید.
- هرگز منبع ولتاژ متناوب را به خروجیهای دستگاه متصل ننمایید.
- هرگز خروجی "اینورتر" را به خازن و یا جرقه گیر متصل ننمایید.
- از اتصال دستگاه به الکتروموتورهای فرسوده، نامرغوب و یا مشکوک به آسیب دیدگی خودداری کنید.
- حتماً از منبع ولتاژی با مشخصات مناسب دستگاه استفاده نمایید. ( ۲۲۰ ولت، ۵۰ هرتز)
- دقت کنید که کلیه اتصالات، محکم و بدون حرکت باشند.
- در صورت استفاده از "اینورتر" در دستگاه‌هایی با درصد خطر بالا، حتماً از مدارات حفاظتی خاص و موانع مکانیکی جهت جلوگیری از حوادث احتمالی استفاده کنید.
- هرگز در هنگام متصل بودن دستگاه به برق اقدام به تغییر سیم‌بندی ترمینال‌ها ننمایید.
- هرگز در هنگام، متصل بودن دستگاه به برق در آن‌را باز ننمایید.



- هرگز در هنگام متصل بودن دستگاه به برق حتی اگر خروجی آن غیر فعال است، ترمینال-های آن را لمس ننمایید. نوع ولتاژ آنها بسیار خطرناک و کشنده می باشد!
- اگر برق ورودی دستگاه حتی برای لحظاتی کوتاه قطع و وصل گردد، امکان شروع به کار آن پس از وصل برق وجود دارد؛ این مسأله می تواند بسیار خطرناک باشد. بنابراین حتماً از مدار فرمانی استفاده کنید که در چنین حالاتی، مانع از ادامه کار "اینورتر" گردد.

 در صورت بروز عیب در دستگاه به علت ناآگاهی و یا سهل انگاری در نصب، ضمانت دستگاه از درجه اعتبار ساقط است.

 نکته: دستگاه "اینورتر"، تا مدتی پس از قطع برق ورودی آن، حاوی و لتاژ می باشد. برای باز کردن در آن حداقل به مدت ۱ دقیقه صبر کنید.

## نگهداری

دستگاه "اینورتر"، مجموعه ای از قطعات الکترونیکی می باشد و طبعاً احتیاج به نگهداری خاصی ندارد، ولی رعایت موارد ذیل می تواند در افزایش طول عمر و کارکرد بی عیب و نقص آن مؤثر باشد.

- در صورت عدم استفاده از دستگاه به مدت طولانی، برق ورودی آن را قطع کنید.
- در صورت آسیب دیدگی کابل های متصل به دستگاه سریعاً نسبت به تعویض آنها اقدام کنید. تا جایی که ممکن است از وصله کردن کابل ها، خصوصاً کابل های خروجی بپرهیزید.
- ترجیحاً دستگاه را در محفظه ای خشک، با تهویه مناسب نصب نمایید.
- در صورت انجام جوشکاری یا هرگونه عملیات برقی با احتمال بروز شوک، ترجیحاً دستگاه را خاموش کرده و برق ورودی آن را قطع کنید.
- از دستکاری "اینورتر" توسط افراد غیر متخصص جلوگیری کنید.
- اگر دستگاه به مدت طولانی در انبار نگهداری شده است، قبل از استفاده، داخل آن را بازدید کرده و در صورت وجود موارد مشکوک، از جمله آثار جانوران موزی و ... از نصب آن خودداری کنید.
- اگر رطوبت محیط محل استفاده دستگاه بالا است، تمهیداتی جهت خشک کردن نسبی هوای اطراف "اینورتر" اتخاذ نمایید.
- اگر یک خطای خاص در عملکرد دستگاه، بدون دلیل مشخصی تکرار می شود، حتماً مورد را به نزدیک ترین نمایندگی شرکت اطلاع دهید.

## شرح مشخصات کلی درایو INVOOTER

"اینورتر" INVOOTER دارای کاربردهای متنوع صنعتی می‌باشد. این درایوها با تکنولوژی PWM و با منحنی ولتاژ- فرکانس خطی کنترل شده و برای استفاده در کاربردهای گشتاور ثابت مورد استفاده قرار می‌گیرد. این درایو دارای سه بخش اصلی قدرت، یوزر و کنترل می‌باشد. بخش قدرت شامل یکسوساز ورودی و مبدل فرکانس است؛ در قسمت یکسوساز، ولتاژ متناوب ورودی توسط دیودها به ولتاژ مستقیم تبدیل شده و بوسیله خازن‌های صافی به صورت ولتاژ یکنواخت، در اختیار بخش مبدل قرار می‌گیرد. در قسمت مبدل، ولتاژ یکسو شده توسط عناصر سوئیچ کننده IGBT به ولتاژ شبه سینوسی سه فاز تبدیل می‌گردد. واحد کنترل در واقع مغز سیستم درایو می‌باشد. و شامل بخش‌های نظارت بر مبدل و خروجی قدرت، ورودی‌ها و خروجی‌های آنالوگ و دیجیتال، کنترل خطاها و ارتباطات سریال می‌باشد. عملکرد صحیح درایو و جلوگیری از ایراد آسیب به درایو و الکتروموتور، توسط سیستم کنترل درایو تضمین شده است.

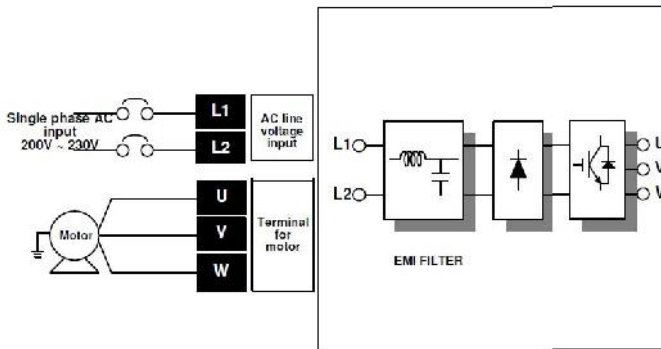

## ویژگی‌های فنی

- از ویژگی‌های اساسی درایو INVOOTER می‌توان به موارد ذیل اشاره نمود:
- دارای دو میکروکنترلر مرتبط به یکدیگر
- دارای حفاظت‌های متعدد از جمله:
- اتصال کوتاه فازها به یکدیگر
- کاهش و افزایش ولتاژ ورودی
- اضافه جریان درایو

## حفاظت اضافه دما

### قطع فاز خروجی

- تنظیم فرکانس خروجی از ۰ تا ۴۰۰ هرتز با دقت ۰/۱
- تنظیم حداقل و حداکثر فرکانس خروجی
- قابلیت قفل نمودن پارامترهای تنظیم شده ( **LOCK** و **UNLOCK** )
- قابلیت بازگردانی پارامترهای تنظیم شده به مقدار اولیه کارخانه ( **RESET FACTORY** )
- دارای پارامترهای متنوع کنترلی و امکان افزودن پارامترهای مورد نیاز مصرف کننده
- امکان تنظیم سطوح خطا
- دارا بودن قابلیت ترمز **DC**
- مجهز به فن خنک کننده جهت تنظیم دمای هیتسینک
- امکان جدا شدن پنل دستگاه و نصب در خارج آن
- مجهز به صفحه نمایش **LED** و صفحه کلید با قابلیت فراگیری آسان
- امکان تنظیم زمان افزایش و کاهش سرعت از ۱ تا ۶۰۰۰ ثانیه
- تنظیم گشتاور راه اندازی
- انتخاب تنظیم کنترل سرعت موتور از ۴ قسمت (صفحه کلید، ولوم روی صفحه کلید، ورودی جریان و ورودی ولتاژ)
- ورودی رفرنس فرکانس از نوع ولتاژ ( ۰ تا ۱۰ ولت)
- ورودی رفرنس فرکانس از نوع جریان ( ۴ تا ۲۰ میلی آمپر)
- ۵ ورودی دیجیتال کنترلی
- ۱ خروجی آنالوگ ولتاژ
- دارای پوشش حفاظتی بردها در مقابل آلودگی محیطی
- مجهز به **EMI** فیلتر در ورودی

نمایش حروف بر روی LED های صفحه نمایش

0	0	A	A	K	K	U	U
1	1	b	B	L	L	V	V
2	2	c	C	m	M	W	W
3	3	d	D	n	N	X	X
4	4	E	E	O	O	Y	Y
5	5	F	F	P	P	Z	Z
6	6	G	G	Q	Q		
7	7	H	H	r	R		
8	8	I	I	S	S		
9	9	J	J	t	T		

### تنظیم پارامترها

به منظور سهولت در راه اندازی و تنظیم پارامترها، منو و پارامترهای نمونه خارجی رایج بازار ساخت شرکت LS به کار رفته است. لذا تنظیمات "اینورتر" مشابه "اینورتر" ۱/۵ کیلو وات LS (ic5) می باشد.

منوی نمایش شامل ۴ گروه زیر می باشد :

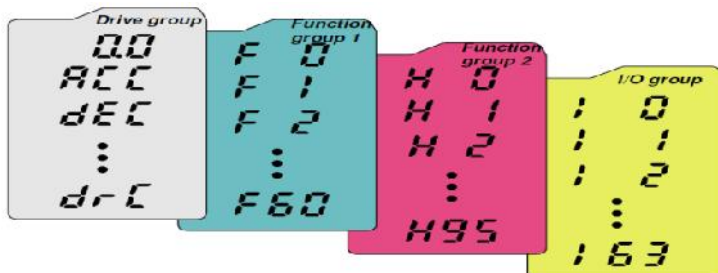

Drive group	Basic parameters necessary for the inverter to run. Parameters such as Target frequency, Accel/Decel time are settable.
Function group 1	Basic function parameters to adjust output frequency and voltage.
Function group 2	Advanced function parameters to set parameters for such as PID Operation and second motor operation.
I/O (Input/Output) group	Parameters necessary to make up a sequence using Multi-function input/output terminal.

برای جابجایی بین گروه‌ها، از دکمه های LEFT یا RIGHT واقع بر روی پنل استفاده

نمایید.

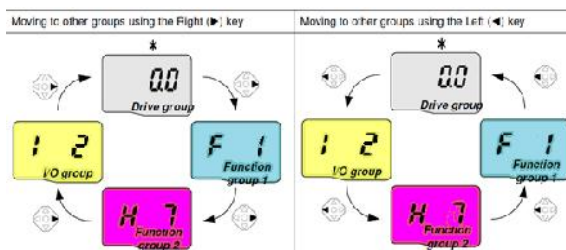

برای جابجایی بین پارامترهای هر گروه از دکمه های UP یا DOWN واقع بر روی پنل استفاده

نمایید.

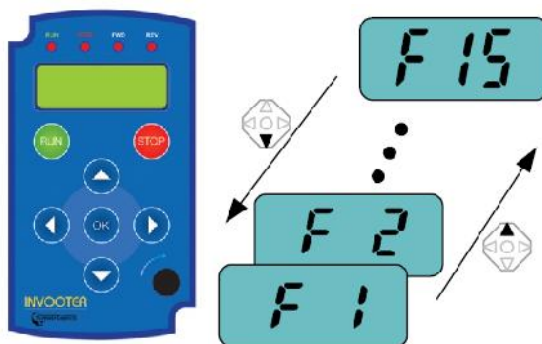

برای تغییر مقدار هر پارامتر ، ابتدا به محل پارامتر مورد نظر رفته و دکمه OK را می‌فشاریم. سپس با تغییر مقدار مورد نظر با استفاده از دکمه‌های UP، DOWN، RIGHT LEFT مقدار نهایی را تنظیم نموده و با فشردن دکمه OK آن را تایید می‌نماییم.

برای مثال مراحل تغییر مقدار پارامتر ACC از ۵ به مقدار ۱۶ را در زیر مشاهده می‌نمایید:

Changing parameter value

When changing ACC time from 5.0 sec to 16.0

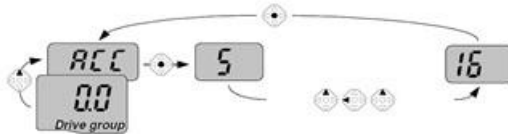

### لیست پارامترهای عملکرد "اینورتر"

LED display	Parameter name	Min/Max range	Description	Factory defaults	Adjustable during run	
0.0	[Frequency command]	0/400 [Hz]	This parameter sets the frequency that the inverter is commanded to output. During Stop: Frequency Command During Run: Output Frequency During Multi-step operation: <u>Multi-step frequency 0</u> . It cannot be set greater than F21- [Max frequency].	0.0	0	
ACC	[Accel time]	0/6000	During Multi-Accel/Decel operation, this parameter serves as Accel/Decel	5.0	0	
dEC	[Decel time]	[sec]		10.0	0	
Drv	[Drive mode] (Run/Stop mode)	0/3	0	Run/Stop via Run/Stop key on the keypad		
			1	Run/Stop via control terminal	FX : Motor forward run RX : Motor reverse run	1
			2		FX : Run/Stop enable RX : Motor reverse rotation	
			3	Operation via Communication Option		
Frq	[Frequency mode]	0/8	0	Digital	Setting via Keypad 1	
			1		Setting via Keypad 2	
			2	Analog	Setting via potentiometer on the keypad (V0)	
			3		Setting via V1 terminal	
			4		Setting via I terminal	
			5		Setting via potentiometer on the keypad + I terminal	
			6		Setting via V1 + I terminal	
			7		Setting via potentiometer on the keypad + V1 terminal	
8		Modbus-RTU Communication				
St1	[Multi-Step frequency 1]	0/400 [Hz]	This parameter sets Multi-Step frequency 1 during Multi-step operation.	10.0	0	

St2	[Multi-Step frequency 2]		This parameter sets Multi-Step frequency 2 during Multi-step operation.	20.0	0
St3	[Multi-Step frequency 3]		This parameter sets Multi-Step frequency 3 during Multi-step operation.	30.0	0

LED display	Parameter name	Min/Max range	Description	Factory defaults	Adjustable during run	
CUr	[Output current]		This parameter displays the output current to the motor.	-	-	
rPM	[Motor RPM]		This parameter displays the number of Motor RPM.	-	-	
dCL	[Inverter DC]		This parameter displays DC link voltage inside the inverter.	-	-	
vOL	[User display select]		This parameter displays the item selected at H73- [Monitoring item select].	vOL	-	
			vOL			Output voltage
			POr			Output power
			tOr			Torque
nOn	[Fault Display]		This parameter displays the types of faults, frequency and operating status at the time of the fault	-	-	
drC	[Direction of motor rotation select]	F/r	This parameter sets the direction of motor rotation when drv - [Drive mode] is set to either	F	0	
		F	Forward			
		r	Reverse			



LED display	Parameter name	Min/Max range	Description		Factory defaults	Adjustable during run
F 0	[Jump code]	0/60	This parameter sets the parameter code number to jump.		1	0
F 1	[Forward/Reverse run disable]	0/2	0	Fwd and rev run enable	0	X
			1	Forward run disable		
			2	Reverse run disable		
F 2	[Accel pattern]	0/1	0	Linear	0	X
F 3	[Decel pattern]		1	S-curve		
F 4	[Stop mode select]	0/2	0	Decelerate to stop	0	X
			1	Stop via DC brake		
			2	Free run to stop		
F 8 1)	[DC Brake start frequency]	0/60 [Hz]	This parameter sets DC brake start frequency. It cannot be set below F23 - [Start frequency].		5.0	X
F 9	[DC Brake wait time]	0/60 [sec]	When DC brake frequency is reached, the inverter holds the output for the setting time before starting DC brake.		1.0	X
F10	[DC Brake voltage]	0/200 [%]	This parameter sets the amount of DC voltage applied to a motor. It is set in percent of H33 – [Motor rated current].		50	X
<b>LED display</b>	[DC Brake time]	0/60 [sec]	This parameter sets the time taken to apply DC current to a motor while motor is at a stop.		1.0	X
F12	[DC Brake start voltage]	0/200 [%]	This parameter sets the amount of DC voltage before a motor starts to run. It is set in percent of H33 – [Motor rated current].		50	X
F13	[DC Brake start time]	0/60 [sec]	DC voltage is applied to the motor for DC Brake start time before motor accelerates.		0	X
F14	[Time for magnetizing a motor]	0/60 [sec]	This parameter applies the current to a motor for the set time before motor accelerates during Sensorless vector control.		1.0	X

LED display	Parameter name	Min/Max range	Description	Factory defaults	Adjustable during run	
F29	[Torque boost in reverse direction]		This parameter sets the amount of torque boost applied to a motor during reverse run. It is set as a percent of Max output voltage	5	X	
F30	[V/F pattern]	0/2	0	{Linear}	0	X
			1	{Square}		
			2	{User V/F}		
F31	[User V/F frequency 1]	0/400 [Hz]	<p>This parameter is active when F30 – [V/F pattern] is set to 2 {User V/F}.</p> <p>It cannot be set above F21 – [Max frequency].</p> <p>The value of voltage is set in percent of H70 – [Motor rated voltage].</p> <p>The values of the lower-numbered parameters cannot be set above those of higher-numbered.</p>	15.0	X	
F32	[User V/F voltage 1]	0/100 [%]		25	X	
F33	[User V/F frequency 2]	0/400 [Hz]		30.0	X	
F34	[User V/F voltage 2]	0/100 [%]		50	X	
F35	[User V/F frequency 3]	0/400 [Hz]		45.0	X	
F36	[User V/F voltage 3]	0/100 [%]		75	X	
F37	[User V/F frequency 4]	0/400 [Hz]		60.0	X	
F38	[User V/F voltage 4]	0/100 [%]		100	X	
F39	[Output voltage adjustment]	40/110 [%]	This parameter adjusts the amount of output voltage. The set value is the percentage of input voltage	100	X	
F40	[Energy-saving level]	0/30 [%]	This parameter decreases output voltage according to load status.	0	0	
F50	[Electronic thermal select]	0/1	This parameter is activated when the motor is overheated (time-inverse).	0	0	

LED display	Parameter name	Min/Max range	Description		Factory defaults	Adjustable during run
F51 4)	[Electronic thermal level for 1 minute]	50/200 [%]	This parameter sets max current capable of flowing to the motor continuously for 1 minute. The set value is the percentage of H33 – [Motor rated current]. It cannot be set below F52 – [Electronic thermal level for continuous].		150	0
F52	[Electronic thermal level for continuous]		This parameter sets the amount of current to keep the motor running continuously. It cannot be set higher than F51 – [Electronic thermal level for 1 minute].		100	0
F53	[Motor cooling method]	0/1	0	Standard motor having cooling fan directly connected to the shaft	0	0
			1	A motor using a separate motor to power a cooling fan.		
F54	[Overload warning level]	30/150 [%]	This parameter sets the amount of current to issue an alarm signal at a relay or multi-function output terminal (see I54, I55). The set value is the percentage of H33- [Motor rated current].		150	0
F55	[Overload warning time]	0/30 [sec]	This parameter issues an alarm signal when the current greater than F54- [Overload warning level] flows to the motor for F55- [Overload warning time].		10	0
F56	[Overload trip select]	0/1	This parameter turns off the inverter output when motor is overloaded.		1	0
F57	[Overload trip level]	30/200 [%]	This parameter sets the amount of overload current. The value is the percentage of H33- [Motor rated current].		180	0
F58	[Overload trip time]	0/60 [sec]	This parameter turns off the inverter output when the F57- [Overload trip level] of current flows to the motor for F58- [Overload trip time].		60	0

LED display	Parameter name	Min/Max range	Description	Factory defaults	Adjustable during run			
F59	[Stall prevention select]	0/7	This parameter stops accelerating during acceleration, decelerating during constant speed run and stops decelerating during deceleration.	0	X			
						During Deceleration	During constant speed	During Acceleration
						Bit 2	Bit 1	Bit 0
			0			-	-	-
			1			-	-	
			2			-		-
			3			-		
			4				-	-
			5				-	
			6					-
7								
F60	[Stall prevention level]	30/150 [%]	<p>This parameter sets the amount of current to activate stall prevention function during Accel, constant or Decel run.</p> <p>The set value is the percentage of the H33- [Motor rated current].</p>	150	X			

LED display	Parameter name	Min/Max range	Description	Factory defaults	Adjustable during run
H 0	[Jump code]	1/95	This parameter sets the code number to jump.	1	0
H 1	[Fault history 1]	-	This parameter stores information on the types of faults, the frequency, the current and the Accel/Decel condition at the time of fault (see page 1000). The last fault is automatically stored in the H 1- [Fault history 1].	nOn	-
H 2	[Fault history 2]	-		nOn	-
H 3	[Fault history 3]	-		nOn	-
H 4	[Fault history 4]	-		nOn	-
H 5	[Fault history 5]	-		nOn	-
H 6	[Reset fault history]	0/1	This parameter clears the fault history saved in H 1-5.	0	0
H 7	[Dwell frequency]	F23/400 [Hz]	When run frequency is issued, motor starts to accelerate after dwell frequency is applied to the motor during H8- [Dwell time]. [Dwell frequency] can be set within the range of F21- [Max frequency] and F23- [Start frequency].	5.0	X
H 8	[Dwell time]	0/10 [sec]	This parameter sets the time for dwell operation.	0.0	X
H10	[Skip frequency select]	0/1	This parameter sets the frequency range to skip to prevent undesirable resonance and vibration on the structure of the machine.	0	X
H11	[Skip frequency low limit 1]	0/400 [Hz]	Run frequency cannot be set within the range of H11 thru H16. The frequency values of the low numbered parameters cannot be set above those of the high numbered ones.	10.0	X
H12	[Skip frequency high limit 1]			15.0	X
H13	[Skip frequency low limit 2]			20.0	X
H14	[Skip frequency high limit 2]			25.0	X
H15	[Skip frequency low limit 3]			30.0	X

LED display	Parameter name	Min/Max range	Description	Factory defaults	Adjustable during run
H16	[Skip frequency high limit 3]			35.0	X
H17	S-Curve accel/decel start side	1/100 [%]	Set the speed reference value to form a curve at the start during accel/decel. If it is set higher, linear zone gets smaller.	40	X
H18	S-Curve accel/decel end side	1/100 [%]	Set the speed reference value to form a curve at the end during accel/decel. If it is set higher, linear zone gets smaller.	40	X
H19	[Output phase loss protection select]	0/1	Inverter turns off the output when the phase of the inverter output (U, V, W) is not properly connected.	0	O
H20	[Power On Start select]	0/1	This parameter is activated when drv is set to 1 or 2 (Run/Stop via Control terminal). Motor starts acceleration after AC power is applied while FX or RX terminal is ON.	0	O
H21	[Restart after fault reset]	0/1	This parameter is active when drv is set to 1 or 2 (Run/Stop via Control terminal). Motor accelerates after the fault condition is reset while the FX or RX terminal is ON.	0	O

LED display	Parameter name	Min/Max range	Description				Factory defaults	Adjustable during run	
H22 2)	[Speed Search Select]	0/15	This parameter is active to prevent any possible fault when the inverter outputs its voltage to the running motor.				0	O	
				1. H20- [Power On start]	2.Restart after instant power failure	3.Operation after fault occurred			4.Norma l acceleration
				Bit 3	Bit 2	Bit 1			Bit 0
			0	-	-	-			-
			1	-	-	-			-
			2	-	-	-			-
			3	-	-	-			-
			4	-	-	-			-
			5	-	-	-			-
			6	-	-	-			-
			7	-	-	-			-
			8	-	-	-			-
			9	-	-	-			-
			10	-	-	-			-
			11	-	-	-			-
			12	-	-	-			-
13	-	-	-	-					
14	-	-	-	-					
15	-	-	-	-					
H23	[Current level during Speed search]	80/20 0 [%]	This parameter limits the amount of current during speed search. The set value is the percentage of the H33- [Motor rated current].				100	O	
H24	[P gain during Speed search]	0/9999	It is the Proportional gain used for Speed Search PI controller.				100	O	
H25	[I gain during speed search]	0/9999	It is the Integral gain used for Speed search PI controller.				1000	O	

LED display	Parameter Name	Min/Max Range	Description	Factory defaults	Adjustable during run	
H26	[Number of Auto Restart try]	0/10	This parameter sets the number of restart tries after a fault occurs. Auto Restart is deactivated if the fault outnumbers the restart tries. This function is active when [drv] is set to 1 or 2 {Run/Stop via control terminal}. active during protection function (OHT, LVT, EXT, HWT etc.)	0	O	
H27	[Auto Restart time]	0/60 [sec]	This parameter sets the time between restart tries.	1.0	O	
H30	[Motor type select]	0.2/2.2	0.2	0.2 kW	0.4 1)	X
			0.4	0.4 kW		
			0.75	0.75 kW		
			1.5	1.5 kW		
			2.2	2.2 kW		
H31	[Number of motor poles]	2/12	This setting is displayed via rpm in drive group.	4	X	
H32	[Rated slip frequency]	0/10 [Hz]	$f_r = f_s - \frac{rpm \times P}{120}$ <p>Where, <math>f_s</math> = Rated slip frequency</p> <p><math>f_r</math> = Rated frequency</p> <p><math>rpm</math> = Motor nameplate RPM</p> <p><math>P</math> = Number of Motor poles</p>	3.0 2)	X	
H33	[Motor rated current]	1.0/20 [A]	current rated motor on Enter the nameplate.	1.8	X	
H34	[No Load Motor Current]	0.1/12 [A]	Enter the current value detected when the motor is rotating in rated rpm after the load connected to the motor shaft is removed. Enter the 50% of the rated current value when it is difficult to measure H34 - [No Load Motor Current].	0.9	X	
H36	[Motor efficiency]	50/100 [%]	Enter the motor efficiency (see motor nameplate).	72	X	



LED display	Parameter Name	Min/Max Range	Description		Factory defaults	Adjustable during run
H37	[Load inertia rate]	0/2	Select one of the following according to motor inertia.		0	X
			0	Less than 10 times that of motor inertia		
			1	About 10 times that of motor inertia		
			2	More than 10 times that of motor inertia		
H39	[Carrier frequency select]	1/15 [kHz]	This parameter affects the audible sound of the motor, noise emission from the inverter, inverter temp, and leakage current. If the value is set higher, the inverter sound is quieter but the noise from the inverter and leakage current will become greater.		3	O
H40	[Control mode select]	0/3	0	{Volts/frequency Control}	0	X
			1	{Slip compensation control}		
			2	{PID Feedback control}		
			3	{Sensorless vector control}		
H41	[Auto tuning]	0/1	If this parameter is set to 1, it automatically measures parameters of the H42 and H43		0	X
H42	[Stator resistance (Rs)]	0/5.0[Ω]	This is the value of the motor stator resistance.		-	X
H44	[Leakage inductance (Lσ)]	0/300.0 [mH]	This is leakage inductance of the stator and rotor of the motor.		-	X
H45	Sensorless P gain	0/32767	P gain for Sensorless control		1000	O
H46	Sensorless I gain		I gain for Sensorless control		100	O
H50 3)	[PID Feedback select]	0/1	0	Terminal I input (0 ~ 20 mA)	0	X
			1	Terminal V1 input (0 ~ 10 V)		

LED display	Parameter Name	Min/Max Range	Description		Factory defaults	Adjustable during run
H51	[P gain for PID controller]	0/999.9 [%]	This parameter sets the gains for the PID controller.		300.0	O
H52	[Integral time for PID controller (I gain)]	0.1/32.0 [sec]			1.0	O
H53	Differential time for PID controller	0.0 /30.0 [sec]			0.0	O
H54	F gain for PID controller	0/999.9 [%]	This is the Feed forward gain for the PID controller.		0.0	O
H55	[PID output frequency limit]	0/400 [Hz]	This parameter limits the amount of the output frequency thru the PID control. The value is settable within the range of F21 – [Max frequency] and H23 – [Start frequency].		60.0	O
H70	[Frequency Reference for Accel/Decel]	0/1	0	The Accel/Decel time is the time that takes to reach the F21 – [Max frequency] from 0 Hz.	0	X
			1	The Accel/Decel time is the time that takes to reach a target frequency from the run frequency.		
H71	[Accel/Decel time scale]	0/2	0	Settable unit: 0.01 second.	1	O
			1	Settable unit: 0.1 second.		
			2	Settable unit: 1 second.		
H72	[Power on display]	0/13	This parameter selects the parameter to be displayed on the keypad when the input power is first applied.		0	O
			0	Frequency command		
			1	Accel time		
			2	Decel time		
			3	Drive mode		
4	Frequency mode					

LED	Parameter	Min/Max	Description		Factory	Adjust
disolv	Name	Range			default	able
			5	Multi-Step frequency 1		
			6	Multi-Step frequency 2		
			7	Multi-Step frequency 3		
			8	Output current		
			9	Motor rpm		
			10	Inverter DC link voltage		
			11	User display select		
			12	Fault display		
			13	Direction of motor rotation select		
H73	[Monitoring item select]	0/2	One of the following can be monitored via vOL - [User display select].		0	O
			0	Output voltage [V]		
			1	Output power [kW]		
			2	Torque [kgf · m]		
H74	[Gain for Motor rpm display]	1/1000 [%]	<p>This parameter is used to change the motor speed display to rotating speed (r/min) or mechanical speed (m/mi).</p> $RPM = \frac{120 \times f}{31} \times \frac{H74}{H}$		100	O
H79	[Software version]	0/10.0	This parameter displays the inverter software version.		1.0	X
H81	[2 <sup>nd</sup> motor Accel time]	0/6000 [sec]	This parameter is active when the selected terminal is ON after I20-I24 is set to 12 [2 <sup>nd</sup> motor select].		5.0	O
H82	[2 <sup>nd</sup> motor Decel time]				10.0	O
H83	[2 <sup>nd</sup> motor base frequency]	30/400 [Hz]			60.0	X
H84	[2 <sup>nd</sup> motor V/F pattern]	0/2			0	X
H85	[2 <sup>nd</sup> motor forward torque boost]	0/15 [%]			5	X

LED display	Parameter Name	Min/Max Range	Description	Factory defaults	Adjustable during run
H86	[2 <sup>nd</sup> motor reverse torque boost]			5	X
H87	[2 <sup>nd</sup> motor stall prevention level]	30/150 [%]		150	X
H88	[2 <sup>nd</sup> motor Electronic thermal level for 1 min]	50/200 [%]		150	O
H89	[2 <sup>nd</sup> motor Electronic thermal level for continuous]			100	O
H90	[2 <sup>nd</sup> motor rated current]	0.1/20 [A]		1.8	X
H93	[Parameter initialize]	0/5		This parameter is used to initialize parameters back to the factory default values.	
			0	-	
			1	All parameter groups are initialized to factory default value.	
			2	Only Drive group is initialized.	
			3	Only Function group 1 is initialized.	
			4	Only Function group 2 is initialized.	
5	Only I/O group is initialized.				
H94	[Password register]	0/FFF	Password for H95-[Parameter lock].	0	O
H95	[Parameter lock]	0/FFF	This parameter is able to lock or unlock parameters by typing password registered in H94.		
			UL (Unlock)	Parameter change enable	
			L (Lock)	Parameter change disable	

LED display	Parameter name	Min/Max range	Description	Factory defaults	Adjustable during run
I 0	[Jump code]	0/63	This parameter sets the code number to jump	1	0
I 1	[Filter time constant for V0 input]	0/9999	This is used to adjust the analog voltage input signal via keypad potentiometer.	10	0
I 2	[V0 input Min voltage]	0/10 [V]	Set the minimum voltage of the V0 input.	0	0
I 3	[Frequency corresponding to I 2]	0/400 [Hz]	Set the inverter output minimum frequency at minimum voltage of the V0 input.	0.0	0
I 4	[V0 input Max voltage]	0/10 [V]	Set the maximum voltage of the V0 input.	10	0
I 5	[Frequency corresponding to I 4]	0/400 [Hz]	Set the inverter output maximum frequency at maximum voltage of the V0 input.	60.0	0
I 6	[Filter time constant for V1 input]	0/9999	Set the input section's internal filter constant for V1 input.	10	0
I 7	[V1 input Min voltage]	0/10 [V]	Set the minimum voltage of the V1 input.	0	0
I 8	[Frequency corresponding to I 7]	0/400 [Hz]	Set the inverter output minimum frequency at minimum voltage of the V1 input.	0.0	0
I 9	[V1 input max voltage]	0/10 [V]	Set the maximum voltage of the V1 input.	10	0
I10	[Frequency corresponding to I 9]	0/400 [Hz]	Set the inverter output maximum frequency at maximum voltage of the V1 input.	60.0	0
I11	[Filter time constant for I input]	0/9999	Set the input section's internal filter constant for I input.	10	0
I12	[I input minimum current]	0/20 [mA]	Set the Minimum Current of I input.	4	0

LED display	Parameter name	Min/Max range	Description		Factory defaults	Adjustable during run
I13	[Frequency corresponding to I 12]	0/400 [Hz]	Set the inverter output minimum frequency at minimum current of I input.		0.0	0
I14	[I input max current]	0/20 [mA]	Set the Maximum Current of I input.		20	0
I15	[Frequency corresponding to I 14]	0/400 [Hz]	Set the inverter output maximum frequency at maximum current of I input.		60.0	0
I16	[Criteria for Analog Input Signal loss]	0/2	0	Disabled	0	0
			1	Less than half the value set in I 2/7/12 entered		
			2	Below the value set in I 2/7/12 entered		
I20	[Multi-function input terminal P1 define]	0/24	0	Forward run command {FX}	0	0
			1	Reverse run command {RX}		
I21	[Multi-function input terminal P2 define]	0/24	2	Emergency Stop Trip {EST}	1	0
			3	Reset when a fault occurs {RST}.		
I22	[Multi-function input terminal P3 define]	0/24	4	Jog operation command {JOG}	2	0
			5	Multi-Step frequency – Low		
I23	[Multi-function input terminal P4 define]	0/24	6	Multi-Step frequency – Mid	3	0
			7	Multi-Step frequency – High		
I24	[Multi-function input terminal P5 define]	0/24	8	Multi Accel/Decel – Low	4	0
			9	Multi Accel/Decel – Mid		
			10	Multi Accel/Decel – High		
			11	DC brake during stop		
			12	2 <sup>nd</sup> motor select		
			13	-		
			14	-		
			15	Up-down operation		

LE D	Parameter nam	Min/Max rang	Description					Factory defaults	Adjustable during run	
			16				Frequency decrease command (DOWN)			
			17	3-wire operation						
			18	External trip: A Contact (EtA)						
			19	External trip: B Contact (EtB)						
			20							
			21	Exchange between PID operation and V/F operation						
			22	Exchange between option and Inverter						
			23	Analog Hold						
			24	Accel/Decel Disable						
I25	[Input terminal status display]		BIT4	BIT3	BIT2	BIT1	BIT0	-	-	
			P5	P4	P3	P2	P1			
I26	[Output terminal status display]						BIT1	BIT0		
							30AC	MO		
I27	[Filtering time constant for Multi-function Input terminal]	2/50	If the value is set higher, the response of the Input terminal is getting slower.					15	0	
I30	[Multi-Step frequency 4]	0/400 [Hz]	It cannot be set greater than F21 – [Max frequency].					30.0	0	
I31	[Multi-Step frequency 5]							25.0	0	
I32	[Multi-Step frequency 6]							20.0	0	
I33	[Multi-Step frequency 7]							15.0	0	
I34	[Multi-Accel time 1]	0/6000 [sec]						3.0	0	
I35	[Multi-Decel time 1]							3.0		

LED display	Parameter name	Min/Max range	Description		Factory defaults	Adjustable during run	
I36	[Multi-Accel time 2]				4.0		
I37	[Multi-Decel time 2]				4.0		
I38	[Multi-Accel time 3]				5.0		
I39	[Multi-Decel time 3]				5.0		
I40	[Multi-Accel time 4]				6.0		
I41	[Multi-Decel time 4]				6.0		
I42	[Multi-Accel time 5]				7.0		
I43	[Multi-Decel time 5]				7.0		
I44	[Multi-Accel time 6]				8.0		
I45	[Multi-Decel time 6]				8.0		
I46	[Multi-Accel time 7]				9.0		
I47	[Multi-Decel time 7]				9.0		
I50	[Analog output item select]	0/3			10[V] Output	0	O
			0	Output frequency	Max frequency		
			1	Output current	150 %		
			2	Output voltage	282 V		
			3	DC link voltage	DC 400V		
I51	[Analog output level adjustment]	10/200 [%]			100	O	



LED display	Parameter name	Min/Max rang	Description			Factory defaults	Adjustable during run
I52	[Frequency detection level]	0/400 [Hz]	This parameter is used when I54 – [Multi-function output terminal select] or I55 – [Multi-function relay select] are set to 0-4. It cannot be set greater than F21 – [Max frequency].			30.0	0
I53	[Frequency detection bandwidth]					10.0	0
I54	[Multi-function output terminal select]	0/17	0	FDT-1	12	0	
I55	[Multi-function relay select]		1	FDT-2			
			2	FDT-3	17		
			3	FDT-4			
			4	FDT-5			
			5	Overload {OL}			
			6	Inverter Overload {IOL}			
			7	Motor stall {STALL}			
			8	Over voltage trip {OV}			
			9	Low voltage trip {LV}			
			1	Inverter cooling fan overheat {OH}			
			1	Command loss			
			1	During run			
			1	During stop			
			1	During constant run			
			1	During speed searching			
1	Wait time for run signal input						
1	Fault relay output						
I56	[Fault relay output]	0/7	When setting the H26– [Number of auto restart try]	When the tripothor than low voltage trip occurs	When the low voltage trip occurs	2	0
			Bit 2	Bit 1	Bit 0		
			0	-	-		
			1	-	-		

LED display	Parameter name	Min/Max range	Description	Factory defaults	Adjustable during run	
			2 -			
			3 -			
			4 -			
			5 -			
			6 -			
			7			
160	[Inverter station number]	1/32	This parameter is set when the inverter uses RS485 communication option.	1	0	
161	[Baud rate]	0/4	Select the Baud rate of the RS485	3	0	
			0			1200 bps
			1			2400 bps
			2			4800 bps
			3			9600 bps
4	19200 bps					
162	[Drive mode select after loss of frequency command]	0/2	It is used when frequency command is given via V1 and I terminal or communication option.	0	0	
			0			Continuous operation
			1			Free Run stop (Coast to stop)
			2			Decel to stop
163	[Wait time after loss of frequency command]	0.1/12 [sec]	This is the time inverter determines whether there is the input frequency command or not. If there is no frequency command input during this time, inverter starts operation via the mode selected at I62.	1.0	-	

دسته بندی و توضیحات پارامترها مشابه برند LS کره جنوبی، مدل ic5



می باشد. سایر پارامترها هم اکنون فعال نمی باشند و در صورت اعلام نیاز شما مصرف کننده گرامی در آینده لحاظ خواهند شد.

## اتصالات الکتریکی

ارتباط الکتریکی مدارات قدرت و فرمان با دستگاه "اینورتر"، از طریق ترمینال‌های دستگاه برقرار می‌گردد. این ترمینال‌ها عبارتند از مجموعه ورودی و خروجی قدرت و مجموعه ورودی و خروجی سیگنال.

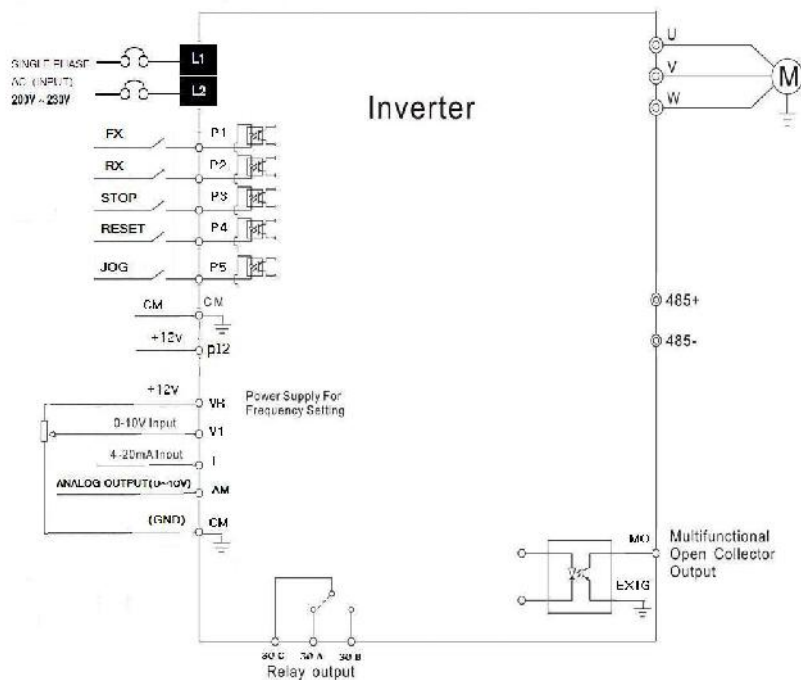

## شرح ترمینال‌های دستگاه

۱- ترمینال‌های مجموعه قدرت، خود شامل دو زیر مجموعه ورودی قدرت و خروجی قدرت می‌باشد ترمینال‌های مجموعه ورودی قدرت شامل ۲ فاز ورودی L1 و L2 می‌باشد. مجموعه خروجی‌های قدرت نیز شامل فازهای U، V و W است.

⚠ در صورت اتصال ترمینال‌های خروجی به منبع ولتاژ، آسیب جدی به دستگاه وارد خواهد شد. چنین خطایی، ضمانت دستگاه را بی اعتبار می نماید.  
۲- مجموعه ورودی‌ها و خروجی سیگنال شامل ترمینال‌های :

ترمینال مشترک گروه فرمان : CM

فرمان چرخش راستگرد : (P1)Fx

فرمان چرخش چپگرد: (P2) Rx

فرمان توقف : (P3) Emergency Stop

فرمان ریست : (P4)Reset

فرمان سرعت دوم: (P5) Jog opration

✓ جهت فعال شدن فرمان با سطح صفر ولت ، جامپر بیرونی را در وضعیت زیر قرار دهید :

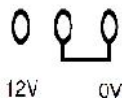

✓ جهت فعال شدن فرمان با سطح ۱۲ ولت ، جامپر بیرونی را در وضعیت زیر قرار دهید :

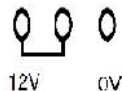

تغذیه ۱۲ ولت : (P12)

( MO ) : Multi-function Transistor Collector Output Terminal

( EXTG) Ground for MO: زمین خروجی چند کاره

( 30 B ) : (normaly open) کنتاكت خروجی

( 30 A ) : (normaly close) کنتاكت خروجی

( 30 C ) : 30 B و 30 A کنتاكت مشترک بین

ADM 485 (485 + ) : برای استفاده از پروتکل مد باس

ADM 485 (485 - ) : برای استفاده از پروتکل مد باس

مجموعه ورودی‌ها و خروجی‌های آنالوگ، شامل ترمینال‌های زیر می باشند:

ترمینال مشترک (GND Analog) برای مجموعه ورودی‌های آنالوگ است : GND

I : ورودی جریان ۴ تا ۲۰ میلی آمپر

V1 : ورودی ولتاژ ۰ تا ۱۰ ولت

خروجی ۱۲+ ولت : VR

جهت فعال شدن ورودی جریان یا ولتاژ، جامپر بیرونی را در وضعیت مناسب قرار دهید :

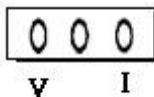

**V1** مخصوص ورودی آنالوگ ۰ تا ۱۰ ولت جهت کنترل دورالکتروموتور می‌باشد. سیگنال مذکور می‌تواند از طریق یک کنترل کننده با خروجی ۰ تا ۱۰ ولت و یا توسط یک پتانسیومتر (ولوم) تامین گردد.

⚠️ حداکثر جریان عبوری از ترمینال نباید بیش تر از ۱۰۰ میلی آمپر باشد وگرنه احتمال آسیب به دستگاه وجود دارد.

VR یک خروجی ۱۲ ولت آنالوگ ولتاژ است که از آن می‌توان به عنوان ورودی آنالوگ برای سایر قسمت‌ها استفاده نمود.

### اتصال "اینورتر" به مدار الکتریکی

اگر چه نحوه ایجاد اتصال الکتریکی دستگاه "اینورتر" به مدارات قدرت و فرمان در محل استفاده، می‌تواند حالات متفاوت و متعددی داشته باشد، ولی اصول کلی برقراری این ارتباط باید همواره رعایت گردد. در این جا ساده ترین مدار لازم جهت راه اندازی "اینورتر" را مشاهده می‌نمایید.

سیستم فرمان به کنتاکتور ( جهت وصل جریان الکتریکی به دستگاه "اینورتر" )، باید با تأخیر عمل نموده و یا به صورت دستی فعال شود تا در هنگام قطع و وصل برق، پس از پایدار شدن ولتاژ، وصل شده (فرمان اتوماتیک) و یا پرسنل مربوطه پس از اطمینان از اتمام شوک‌ها و نوسانات احتمالی شبکه، آنرا متصل کنند.

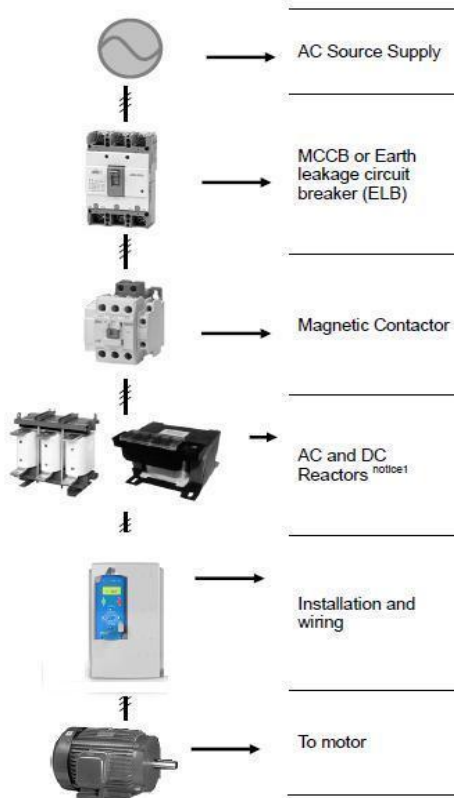

⚠ به هیچ عنوان از قطع و وصل برق ورودی "اینورتر" به منظور راه اندازی و توقف الکتروموتور مربوطه استفاده ننمایید. قطع و وصل مکرر ورودی "اینورتر" باعث بروز آسیب اساسی در دستگاه "اینورتر" خواهد شد.

⚠ پس از قطع ورودی "اینورتر"، حداقل ۳۰ ثانیه صبر نموده و سپس آن را وصل کنید.

⚠ فیوز یا کلید اتوماتیک باید از نوع تندکار بوده و جریان قطع آن متناسب با جریان نامی "اینورتر" و نوع بار متصل به الکتروموتور انتخاب گردد.

⚠ خروجی قدرت "اینورتر" بایستی ترجیحاً به طور مستقیم و توسط کابل شیلددار با مقطع مناسب و با حداقل طول کابل ممکن، به الکتروموتور متصل گردد؛ در صورتی که بنا به عللی، نصب کنتاکتور (یا هر نوع کلید) در خروجی "اینورتر" اجتناب ناپذیر باشد، قطع و وصل

کنتاکتور (یا کلید) مذکور باید در زمان غیر فعال بودن خروجی "اینورتر" انجام پذیرد؛ در غیر اینصورت احتمال بروز آسیب یا خطا در کارکرد دستگاه وجود دارد.

Group	LED Display	Parameter Name	Set Value	Min/Max Range	Factory Defaults	Unit
Drive group	0.0	[Frequency Command]	-	0/400	0.0	Hz
	<b>Frq</b>	<b>[Frequency mode]</b>	<b>0</b>	0/8	0	

Digital Frequency setting via Keypad 1

Run frequency is settable in **0.0** - [Frequency Command].

Set **Frq** – [Frequency mode] to 0 {Frequency setting via Keypad 1}.

Set the desired frequency in **0.0** and press the Prog/Ent ( ) key to enter the value into memory.

The value is settable not greater than **F21** – [Max frequency].

#### Digital Frequency setting via Keypad 2

Group	LED Display	Parameter Name	Set Value	Min/Max Range	Factory Defaults	Unit
Drive group	0	[Frequency Command]	-	0/400	0	Hz
	<b>Frq</b>	<b>[Frequency mode]</b>	<b>1</b>	0/8	0	

Run frequency is settable in **0.0** - [Frequency Command].

Set **Frq** – [Frequency mode] to 1 {Frequency setting via Keypad 2}.

In **0.0**, frequency is changed upon pressing the Up ( )/Down ( ) key. It is selected to use the Up/Down key as potentiometer on keypad.

The value is settable not greater than **F21** – [Max frequency].

Analog Frequency setting via Potentiometer (V0) on the Keypad

Used to prevent fluctuations in analog input signals caused by noise

Group	LED Display	Parameter Name	Set Value	Min/Max Range	Factory Defaults	Unit
Drive group	0	[Frequency Command]	-	-	-	Hz
	<b>F</b>	[Frequency Mode]	<b>2</b>	0/8	0	
I/O group	I	[Filter time constant for V0 input]	10	0/9999	10	
	I	[V0 input minimum voltage]	-	0/10	0	V
	I	[Frequency corresponding to I2]	-	0/400	0	Hz
	I	[V0 input max voltage]	-	0/10	10	V
	I	[Frequency corresponding to I4]	-	0/400	60.0	Hz

Set **Frq** – [Frequency Mode] to 2.

The set frequency can be monitored in **0.0**- [Frequency Command].

Analog Frequency setting via Voltage analog input (0-10V) or potentiometer on the VR terminal

Group	LED Display	Parameter Name	Set Value	Min/Max Range	Factory Default	Unit
Drive group	0	[Frequency command]	-	-	-	Hz
	<b>Frq</b>	[Frequency mode]	<b>3</b>	0/8	0	
I/O group	I 6	[Filtering time constant for V1 input]	10	0/9999	10	
	I 7	[V1 input minimum voltage]	-	0/10	0	V
	I 8	[Frequency corresponding to I 7]	-	0/400	0	Hz
	I 9	[V1 input max voltage]	-	0/10	10	V
	I10	[Frequency corresponding to I 9]	-	0/400	60.0	Hz

Select **Frq** -[Frequency Mode] to 3 {Frequency setting via V1 terminal}.

The 0-10V input can be directly applied from an external controller or a potentiometer (between VR and CM

terminals).

I 1 : [Filtering time constant for V0 input]



Group	LED Display	Parameter Name	Set Value	Min/Max Range	Factory Default	Unit
Drive group	0.0	[Frequency command]	-	-	-	Hz
	<b>Frq</b>	<b>[Frequency mode]</b>	<b>3</b>	0/8	0	
I/O group	l 6	[Filtering time constant for V1 input]	10	0/9999	10	
	l 7	[V1 input minimum voltage]	-	0/10	0	V
	l 8	[Frequency corresponding to l 7]	-	0/400	0.0	Hz
	l 9	[V1 input max voltage]	-	0/10	10	V
	l10	[Frequency corresponding to l 9]	-	0/400	60.0	Hz

Effective for eliminating noise in the frequency setting circuit.

Increase the filter time constant if steady operation cannot be performed due to noise. A larger setting results in slower response (t gets longer).

Analog Frequency setting via Voltage analog input (0-10V) or potentiometer on the VR terminal

Select **Frq** -[Frequency Mode] to 3 {Frequency setting via V1 terminal}.

The 0-10V input can be directly applied from an external controller or a potentiometer (between VR and CM

terminals).

#### Frequency Setting via Analog Current Input (0-20mA)

Group	LED Display	Parameter Name	Set Value	Min/Max Range	Factory Defaults	Unit
Drive group	0	[Frequency Command]	-	-	-	Hz
	<b>Frq</b>	<b>[Frequency Mode]</b>	<b>4</b>	0/8	0	
I/O group	l11	[Filtering time constant for I input]	10	0/9999	10	
	l12	[I input minimum current]	-	0/20	4	mA
	l13	[Frequency corresponding to l 12]	-	0/400	0.0	Hz
	l14	[I input max current]	-	0/20	20	mA
	l15	[Frequency corresponding to l 14]	-	0/400	60.0	Hz

Select **Frq** – [Frequency Mode] to 4 {Current Analog Input (0-20mA)}.

Frequency is set via 0-20mA input between I and CM terminals.

See page 9-2 for I11-I15.

Frequency setting via Potentiometer on the keypad + Current Analog input (0-20mA)

Group	LED Display	Parameter Name	Set Value	Min/Max Range	Factory Defaults	Unit
Drive group	0.0	[Frequency Command]	-	-	-	Hz
	Frq	[Frequency Mode]	5	0/8	0	

Select Frq – [Frequency Mode] to 5 {Potentiometer on the keypad and Current Analog input (0-20mA)}.

Override function is provided via Main speed and Auxiliary speed adjustment.

Related code : I 1 - I 5, I 11- I 15

When main speed is set via potentiometer and Auxiliary speed via 0-20mA analog input, the override

function is set as below.

Group	Code	Parameter Name	Set value	Units
I/O group	I 2	[V0 input minimum voltage]	0	V
	I 3	[Frequency corresponding to I 2]	0	Hz
	I 4	[V0 input max voltage]	10	V
	I 5	[Frequency corresponding to I 4]	60.0	Hz
	I 12	[I input minimum current]	4	mA
	I 13	[Frequency corresponding to I 12]	0	Hz
	I 14	[I input max current]	20	mA
	I 15	[Frequency corresponding to I 14]	5.0	Hz

After the above setting is made, if 5V is set via potentiometer and 10mA is applied via I terminal, 32.5Hz is output

#### Frequency setting via 0-10V + 0-20mA input

Group	LED Display	Parameter Name	Set Value	Min/Max Range	Factory Defaults	Unit
Drive group	0.0	[Frequency Command]	-	-	-	Hz
	<b>Frq</b>	<b>[Frequency Mode]</b>	<b>6</b>	0/8	0	

Set **Frq** – [Frequency Mode] to 6 {V1 + I terminal input}.

Related code : I 6 - I 10, I 11 - I 15

Refer to the **Frequency setting via Potentiometer on the keypad + Current Analog input (0-20mA)** for the setting.

#### Frequency setting via Potentiometer on the keypad + 0-10V input

Group	LED Display	Parameter Name	Set Value	Min/Max Range	Factory Defaults	Unit
Drive group	0.0	[Frequency Command]	-	-	-	Hz
	<b>Frq</b>	<b>[Frequency Mode]</b>	<b>7</b>	0/8	0	

Set **Frq** – [Frequency Mode] to 7 {Potentiometer on the keypad + 0-10V input}.

Relative code: I 1 - I 5, I 6 - I 10

Refer to P 9-4 **Frequency setting via potentiometer on the Keypad + 0-20mA input** for the setting.

Group	LED Display	Parameter Name	Set Value	Min/Max Range	Factory Defaults	Unit
Drive group	Frq	[Frequency Mode]	2/7	0/8	0	
I/O group	I20	[Multi-function input terminal P1 define]	-	0/24	0	
	~	~				
	I24	[Multi-function input Terminal P5 Define]	23		4	

This setting becomes activated when **Frq** – [Frequency Mode] is set to 2-7.

Set one of the Multi-function input terminals to 23 to activate Analog Hold operation.

When I24 –[Multi-function input terminal P5 define] is set to 23,

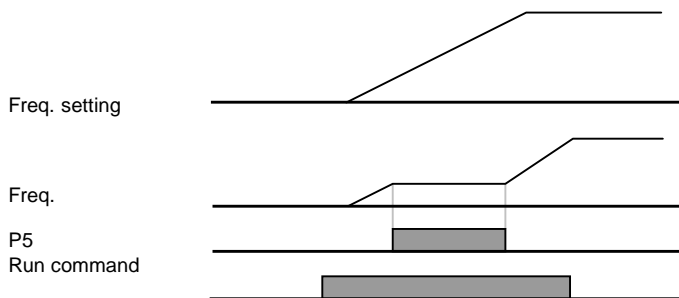

## 9.2 Multi-Step frequency setting

Group	LED Display	Parameter Name	Set Value	Min/Max Range	Factory Defaults	Unit
Drive group	0.0	[Frequency command]	5	0/400	0.0	Hz
	Frq	[Frq mode]	0	0/8	0	-

	St1	[Multi-Step frequency 1]	-	0/400	10.0	Hz
	St2	[Multi-Step frequency 2]	-		20.0	
	St3	[Multi-Step frequency 3]	-		30.0	
I/O group	I22	[Multi-function]	5	0/24	2	-
	I23	[Multi-function]	6		3	-
	I24	[Multi-function]	7		4	-
	I30	[Multi-Step frequency 4]	-	0/400	30.0	Hz
I31	[Multi-Step frequency 5]	-	25.0			
I32	[Multi-Step frequency 6]	-	20.0			
I33	[Multi-Step frequency 7]	-	15.0			

Select a terminal to give Multi-step frequency command among P1-P5 terminals. If terminals P3-P5 are selected for this setting, set I22-I24 to 5-7 to give Multi-step frequency command.

Multi-step frequency 0 is settable using **Frq** – [Frequency mode] and **0.0** – [Frequency command].

Multi-step frequency 1-3 are set at St1-St3 in Drive group, while Step frequency 4-7 are set at I30-I33 in I/O group.

### 9.3 Run Command setting

Run via the Run and STOP/RST key

Group	LED Display	Parameter Name	Set Value	Min/Max Range	Factory Defaults	Unit
Drive group	drv	[Drive mode] (Run/Stop mode)	0	0/3	1	
	drC	[Direction of motor rotation select]	-	F/r	F	

Set **drv** – [Drive mode] to 0.

Motor starts to accelerate by pressing the Run key while run frequency is set. Motor decelerates to stop by pressing the STOP/RST key.

Selecting rotation direction is available at **drC** - [Direction of motor rotation select] when run command is issued via Run key on keypad

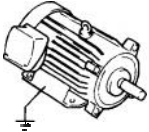

drC	[Direction of motor rotation select]	F	Forward
		R	Reverse

### Run command setting 1 via FX and RX terminals

Group	LED Display	Parameter Name	Set Value	Min/Max Range	Factory Defaults	Unit
Drive group	<b>drv</b>	[Drive mode] (Run/Stop mode)	1	0/3	1	
I/O group	I20	[Multi-function input terminal P1 define]	0	0/24	0	
	I21	[Multi-function input terminal P2 define]	1	0/24	1	

Set **drv** – [Drive mode] to 1.

Set I20 and I21 to 0 and 1 to use P1 and P2 as FX and RX terminals.

"FX" is Forward run command and "RX" Reverse run.

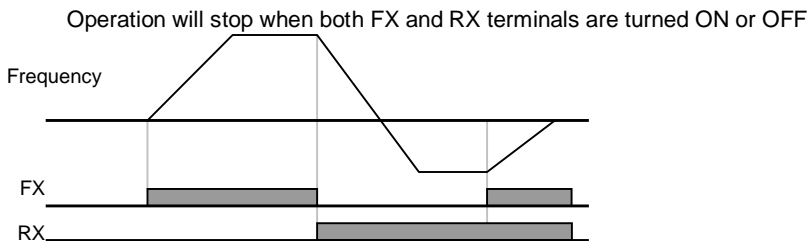

### Run command setting 2 at FX and RX terminals

Group	LED Display	Parameter Name	Set Value	Min/Max Range	Factory Defaults	Unit
Drive group	drv	[Drive mode] (Run/Stop mode)	2	0/3	1	
I/O group	I20	[Multi-function input terminal P1 define]	0	0/24	0	
	I21	[Multi-function input terminal P2 define]	1	0/24	1	

Set the **drv** to 2.

Set I20 and I21 to 0 and 1 to use P1 and P2 as FX and RX terminals.

FX: Run command setting. Motor runs in forward direction when RX terminal (P2) is OFF.

RX: Direction of motor rotation select. Motor runs in reverse direction when RX terminal (P2) is ON.

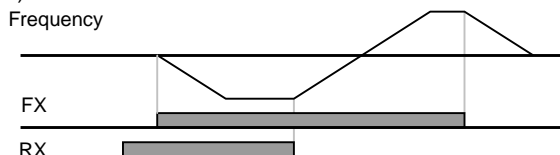

#### FX/RX Run Disable

Group	LED Display	Parameter Name	Set Value	Min/Max Range	Factory Defaults	Unit
Drive group	drC	[Direction of motor rotation select]	-	F/r	F	
Function group 1	F 1	[Forward/Reverse run]	-	0/2	0	

Select the direction of motor rotation.

0 : Forward and Reverse run enable

1 : Forward run disable

2 : Reverse run disable

**Power On Start select**

Group						
Drive group	<b>drv</b>	[Drive mode] (Run/Stop mode)	<b>1, 2</b>	0/3	1	
Function group 2	<b>H20</b>	[Power On Start select]	<b>1</b>	0/1	0	

Set H20 to 1.

When AC input power is applied to the inverter with **drv** set to 1 or 2 {Run via control terminal}, motor starts acceleration.

This parameter is inactive when the **drv** is set to 0 {Run via keypad}.

Restart after fault reset

Group	LED display	Parameter name	Set value	Min/Max range	Factory defaults	Unit
Drive group	<b>Drv</b>	[Drive mode] (Run/Stop mode)	<b>1, 2</b>	0/3	1	
Function group 2	<b>H21</b>	[Restart after fault reset]	<b>1</b>	0/1	0	

Set H21 to 1.

Motor starts acceleration if **drv** is set to 1 or 2 and the selected terminal is ON when a fault is cleared.

This function is inactive when the **drv** is set to 0 {Run via the Keypad}.

**Accel/Decel time setting based on Max frequency**

Group	LED Display	Parameter Name	Set Value	Min/Max Range	Factory Defaults	Unit
Drive group	<b>ACC</b>	[Accel time]	-	0/6000	5.0	sec
	<b>dEC</b>	[Decel time]	-	0/6000	10.0	sec
Function group 1	<b>F21</b>	[Max frequency]	-	0/400	60.0	Hz



Function group 2	H70	[Frequency Reference for Accel/Decel]	0	0/1	0	
	H71	[Accel/Decel Time setting unit]	-	0/2	1	

Set the desired Accel/Decel time at ACC/dEC in Drive group.

If H70 is set to 0 {Max frequency}, Accel/Decel time is the time that takes to reach the max freq from 0 Hz.

Desired Accel/Decel time unit is settable at the H71.

Accel/Decel time is set based on **F21** – [Max frequency]. For instance, if **F21** is set to 60Hz, Accel/Decel

time 5 sec, and run frequency 30Hz, time to reach 30Hz would be 2.5 sec



More precise time unit can be set corresponding to load characteristics as shown below

Code	Parameter Name	Setting range	Set value	Description
H71	[Accel/Decel Time setting unit]	0.01~600.00	0	Unit: 0.01 sec.
		0.1~6000.0	1	Unit: 0.1 sec.
		1~60000	2	Unit: 1 sec.

Accel/Decel time based on Run frequency

Group	LED display	Parameter name	Set value	Min/Max range	Factory defaults	Unit
Drive group	ACC	[Accel time]	-	0/6000	5	sec
	dEC	[Decel time]	-	0/6000	10.0	sec
Function group 2	H70	[Frequency reference for Accel/Decel]	1	0/1	0	

Accel/Decel time is set at the **ACC/dEC**.

If you set H70 to 1 {Delta frequency}, Accel/Decel time is the time that takes to reach a target freq from run freq (Currently operating freq.).

When H70 and Accel time are set to 1 {Delta frequency} and 5 sec, respectively,

(A zone: run freq 10 Hz applied first, B zone: Operating via 10 Hz, different run freq is not issued

C: 30Hz Run freq (in this case, Target freq) issued while 10 Hz run freq is applied. But the preset accel time

5 sec is maintained. )

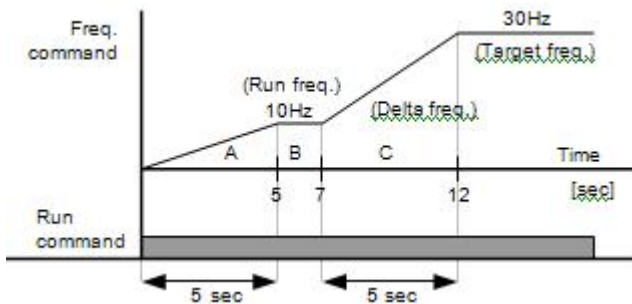

Multi-Accel/Decel time setting via Multi-function terminals

Group	LED Display	Parameter Name	Set Value	Min/Max Range	Factory Defaults	Unit	
Drive group	ACC	[Accel time]	-	0/6000	5	Sec	
	dEC	[Decel time]	-	0/6000	10.0	Sec	
I/O group	I20	[Multi-function input terminal P1 define]	0	0/24	0		
	I21	[Multi-function input terminal P2 define]	1		1		
	I22	[Multi-function input	8		2		
	I23	[Multi-function input	9		3		
	I24	[Multi-function input	10		4		
	I34	[Multi-Accel time 1]	-		0/6000	3	Sec
	~	~					
	I47	[Multi-Decel time 7]	-	9			

Set I22, I23, I24 to 8, 9, 10 if you want to set Multi - Accel/Decel time via P3-P5 terminals.

Multi-Accel/Decel time 0 is settable at ACC and dEC.

Multi-Accel/Decel time 1-7 is settable at I34-I47.

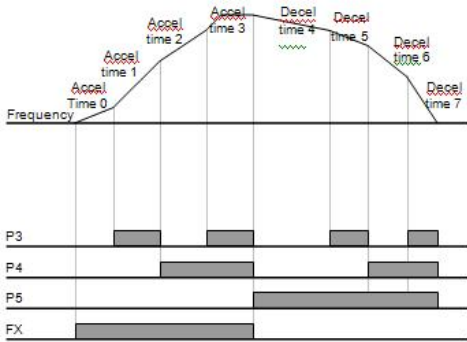

Multi-Accel/Decel time	P5	P4	P3
0	-	-	-
1	-	-	-
2	-	-	-
3	-	-	-
4	-	-	-
5	-	-	-
6	-	-	-
7	-	-	-

### Accel/Decel pattern setting

Group	LED display	Parameter name	Min/Max	Set value	Unit
Function	F 2	[Accel pattern]	0	0	
	F 3	[Decel pattern]	1		
	H17	S-Curve accel/decel start side	1~100	40	%
	H18	S-Curve accel/decel end side		40	%

Accel/Decel pattern is settable at F2 and F3.

Linear : This is a general pattern for constant torque applications

S-curve : This curve allows the motor to accelerate and decelerate smoothly.

Appropriate applications: Elevator door, lifts..

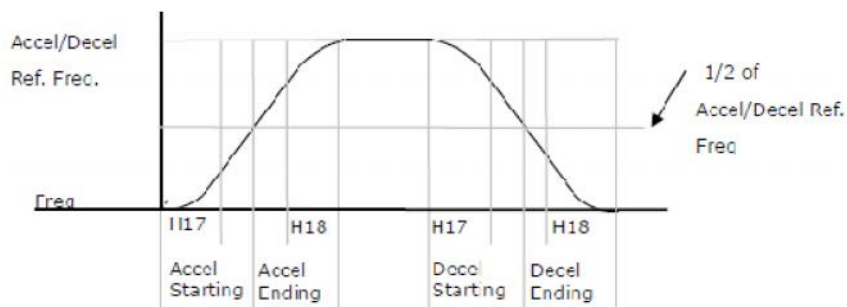
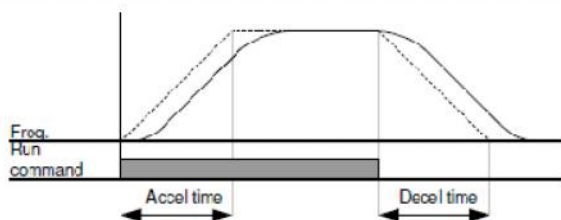

### Accel/Decel Disable

Select one terminal of I20-24 to define Accel/Decel disable.

Group	LED display	Parameter name	Set value	Min/Max range	Factory defaults	Unit
I/O group	I20	[Multi-function input terminal P1 define]	-	0/24	0	
	~	~				
	I24	[Multi-function input terminal P5 define]	24		4	

For example, if P5 is selected, set I24 to 24 to activate this function.

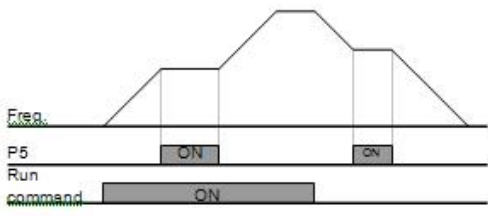

### 9.5 V/F control

#### Linear V/F operation

Group	LED Display	Parameter Name	Set Value	Min/Max Range	Factory Defaults	Unit
Function group 1	F22	[Base frequency]	-	30/400	60.0	Hz
	F23	[Start frequency]	-	0/10.0	0.5	Hz
	F30	[V/F pattern]	0	0/2	0	

Set F30 to 0 {Linear}.

This pattern maintains a linear Volts/frequency ratio from F23 - [Start frequency] to F22- [Base frequency]. This is appropriate for constant torque applications

F22 – [Base frequency] : Inverter outputs its rated voltage at this level. Enter the motor nameplate frequency.

F23 – [Start frequency] : Inverter starts to output its voltage at this level.

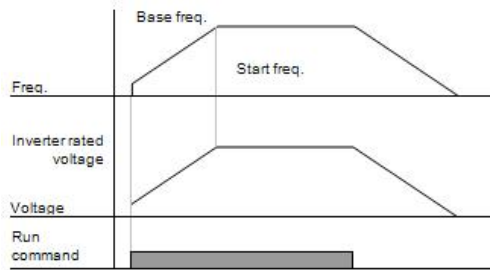

### Square V/F operation

Group	LED Display	Parameter Name	Set Value	Min/Max Range	Factory Defaults	Unit
Function group 1	F30	[V/F pattern]	1	0/2	0	

Set F30 to 1{Square}.

This pattern maintains squared volts/hertz ratio. Appropriate applications are fans, pumps, etc.

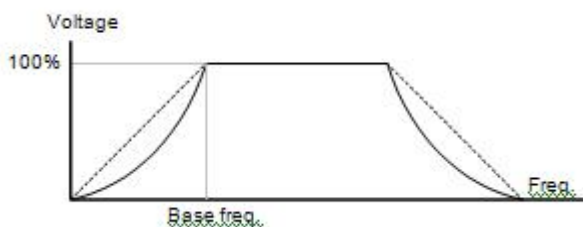

V/F  
pattern

User

Group	LED display	Parametername	Set value	Min/Max range	Factory defaults	Unit
Function group 1	F30	[V/F pattern]	2	0/2	0	
	F31	[User V/F frequency 1]	-	0/400	15.0	Hz
	~	~				
	F38	[User V/F voltage 4]	-	0/100	100	%

Select F30 to 2 {User V/F}.

User can adjust the Volt/Frequency ratio according to V/F pattern of specialized motors and load characteristics.

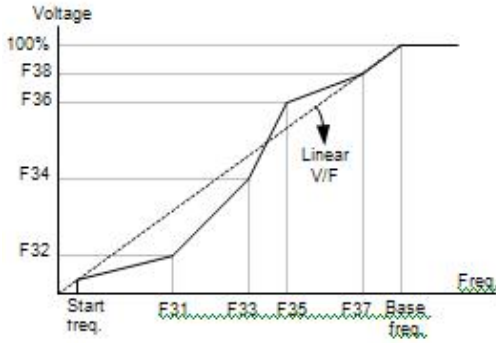

### Output voltage adjustment

Group	LED Display	Parameter Name	Set Value	Min/Max Range	Factory Defaults	Unit
Function group 1	F39	[Output voltage adjustment]	-	40/110	100	%

This function is used to adjust the output voltage of the inverter. This is useful when you use a motor that has

a rated voltage lower than the input voltage

### Boost

### Manual Torque

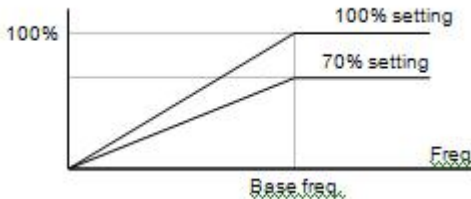



Group	LED display	Parameter name	Set Value	Min/Max	Factory	Unit
Function group 1	F27	[Torque boost select]	0	0/1	0	
	F28	[Torque boost in forward direction]	-	0/15	5	%
	F29	[Torque boost in reverse direction]				

Set F27 to 0 {Manual torque boost}.

The values of [Torque boost in forward/reverse direction] are set separately in F28 and F29.

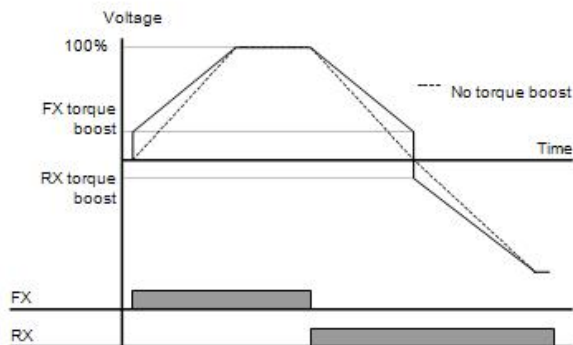

### Auto Torque Boost

Group	LED Display	Parameter Name	Set Value	Min/Max Range	Factory Defaults	Unit
Function group 1	F27	[Torque boost select]	1	0/1	0	
Function group 2	H34	[No Load Motor Current]	-	0.1/12	-	A
	H41	[Auto tuning]	0	0/1	0	
	H42	[Stator resistance (Rs)]	-	0/5.0	-	Ω

Before Auto Torque Boost setting, H34 and H42 should be set correctly (See page 10-6, 10-8).

Set F27 to 1 {Auto torque boost}.

The inverter automatically boosts the output voltage by calculating torque boost value using motor parameters.

## 9.6 Stop mode select

### Decel to stop

Group	LED Display	Parameter Name	Set Value	Min/Max Range	Factory Defaults	Unit
Function group 1	F4	[Stop mode select]	0	0/2	0	

Set F30 to 0 {Decel to stop}.

The inverter decelerates to 0Hz for the preset time.

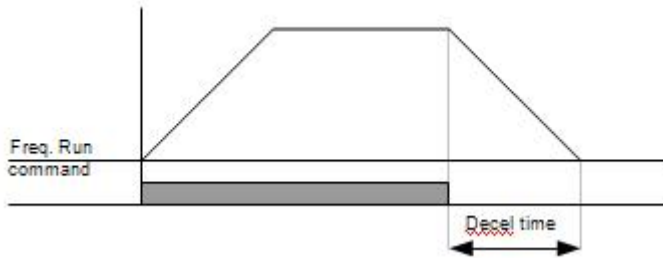

### DC brake to stop

Group	LED Display	Parameter Name	Set Value	Min/Max Range	Factory Defaults	Unit
Function group 1	F4	[Stop mode select]	1	0/2	0	

Set F30 to 1 {DC brake to stop} (See page 10-1 for more).

Free run to stop

Group	LED Display	Parameter Name	Set Value	Min/Max Range	Factory Defaults	Unit
Function group 1	F4	[Stop mode select]	2	0/2	0	

Set F30 to 2 {Free run to stop}.

The inverter turns off the output frequency and voltage when the run command is OFF

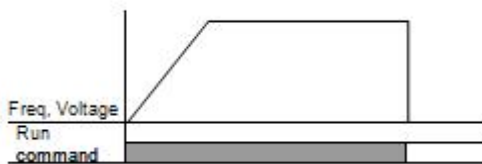

## 9.7 Frequency limit setting

Frequency limit setting based on Max and start frequency

Group	LED display	Parameter name	Set value	Min/Max range	Factory defaults	Unit
Function group 1	F21	[Max frequency]	-	0/400	60.0	Hz
	F23	[Start frequency]	-	0/10	0.5	Hz

Max frequency: Frequency high limit except for F22 [Base frequency]. Any frequency cannot be set above

[Max frequency].

Start frequency: Frequency low limit. If a frequency is set lower than this, 0.00 is automatically set.

Run frequency limit based on frequency High/Low limit

Group	LED Display	Parameter Name	Set Value	Min/Max Range	Factory Defaults	Unit
Function group 1	F24	[Frequency High/Low limit select]	1	0/1	0	
	F25	[Frequency high limit]	-	0/400	60.0	Hz
	F26	[Frequency low limit]	-	0/400	0.5	Hz

Set F24 to 1.

Active run frequency can be set within the range set in F25 and F26.

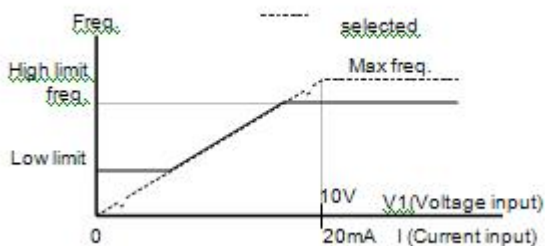

Skip frequency

Group	LED display	Parameter name	Set value	Min/Max range	Factory defaults	Unit
Function group 2	H10	[Skip frequency select]	1	0/1	0	
	H11	[Skip frequency low limit 1]	-	0/400	10.0	Hz
	~	~				
	H16	[Skip frequency high limit 3]	-	0/400	35.0	Hz

Set H10 to 1.

Run frequency setting is not available within the skip frequency range of H11-H16.

Skip frequency is settable within the range of F21 – [Max frequency] and F23 – [Start frequency].

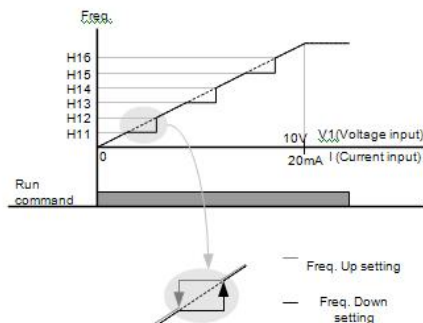

## 10. Advanced functions

### 10.1 DC brake

#### Stop mode via DC brake

Group	LED Display	Parameter Name	Set value	Min/Max Range	Factory Defaults	Unit
Function group 1	F 4	[Stop mode select]	1	0/2	0	
	F 8	[DC Brake start frequency]	-	0/60	5.0	Hz
	F 9	[DC Brake wait time]	-	0/60	1.0	sec
	F10	[DC Brake voltage]	-	0/200	50	%
	F11	[DC Brake time]	-	0/60	1.0	sec

Set F4 - [Stop mode select] to 1.

F 8 : The frequency at which the DC brake will become active.

F 9 : Inverter will wait for this time after F8 - [DC Brake start frequency] before applying F10 - [DC Brake voltage].

F10 : It sets the level as a percent of H33 – [Motor rated current].

F11 : It sets the time that F10 - [DC Brake voltage] is applied to the motor after F 9 - [DC Brake wait time].



Setting F10 or F11 to 0 will disable DC brake.

**F 9 – [DC Brake Wait time] :** When load inertia is great or F 8 – [DC Brake Start Frequency] is high, Over current trip may occur. It can be prevented via F9

Starting DC brake

Group	LED Display	Parameter Name	Set value	Min/Max Range	Factory Defaults	Unit
Function group 1	F12	[DC Brake start voltage]	-	0/200	50	%
	F13	[DC Brake start time]	-	0/60	0	sec

F12 : It sets the level as a percent of H33 – [Motor rated current].

F13 : Motor accelerates after DC voltage is applied for the set time.

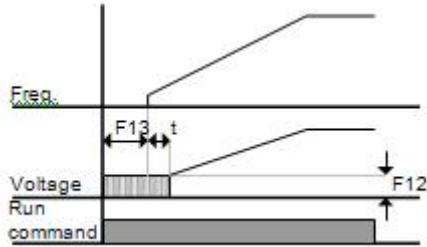

Setting F12 or F13 to 0 will disable Starting DC brake.

**t : After F13 - [DC Brake start time], the frequency is increasing after DC voltage is applied until the time t. In this case, DC Brake start time may be longer than the set value**

DC brake at a stop

Group	LED Display	Parameter Name	Set value	Min/Max Range	Factory Defaults	Unit
Function group 1	F12	[DC Brake start voltage]	-	0/200	50	%
I/O group	I22	[Multi-function input]	11	0/24	2	

F12 : Set as a percent of H33 – [Motor rated current].

Select a terminal to issue a command of DC brake during stop among P1 thru P5.

If P3 terminal is set for this function, set 22 to 11 {DC brake during stop}.

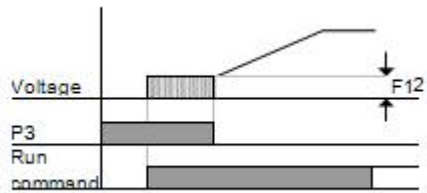

## 10.2 Jog operation

Group	LED display	Parameter name	Set value	Min/Max range	Factory defaults	Unit
Function group 1	F20	Jog frequency	-	0/400	10.0	Hz
I/O group	I22	[Multi-function input terminal P3 define]	4	0/24	2	

Set the desired jog frequency in F20.

**Select the terminal among the Multi-function input terminal P1 thru P5 to use for this setting.**

If P3 is set for Jog operation, set I22 to 4 {Jog}.

Jog frequency can be set within the range of F21 - [Max frequency] and F22 – [Start frequency].

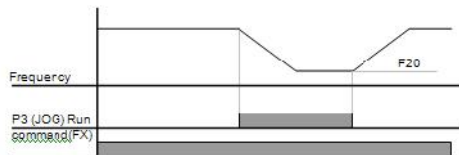
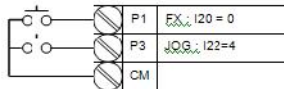



### 10.3 Up-Down operation

Group	LED display	Parameter name	Set value	Min/Max range	Factory defaults	Unit
I/O group	I20	[Multi-function input terminal P1 define]	0	0/24	2	
	~	~				
	I23	[Multi-function input	15		3	
	I24	[Multi-function input	16	4		

#### **Select terminals for Up-Down operation among P1 thru P5.**

If P4 and P5 are selected, set I23 and I24 to 15 (Frequency Up command) and 16 (Frequency Down command), respectively.

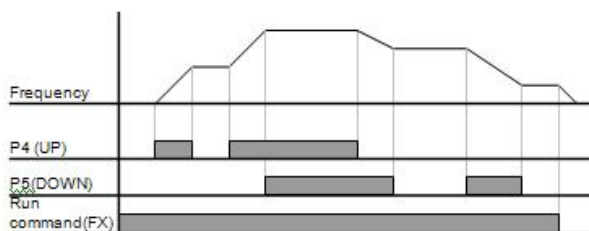

### 10.4 3-Wire Operation

Group	LED display	Parameter name	Set value	Min/Max range	Factory defaults	Unit
I/O group	I20	[Multi-function input terminal P1 define]	0	0/24	2	
	~	~				
	I24	[Multi-function terminal P5 define]	17		4	

**Select the terminal among P1 thru P5 for use as 3-Wire operation.**

If P5 is selected, set I24 to 17 {3-Wire operation}.

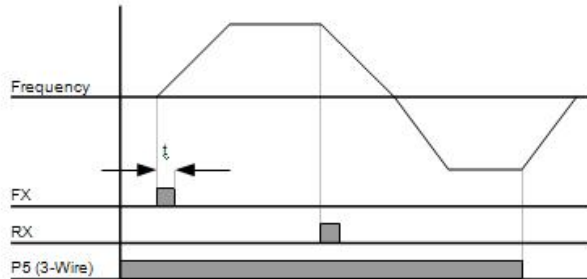
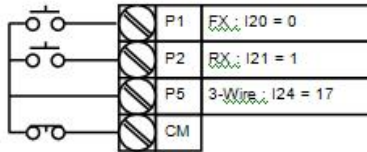

### 10.5 Dwell operation

Group	LED Display	Parameter Name	Set value	Min/Max Range	Factory Defaults	Unit
Function group 2	H 7	[Dwell frequency]	-	0/400	5	Hz
	H 8	[Dwell time]	-	0/10	0	sec

In this setting, motor begins to accelerate after dwell operation is executed for dwell time at the dwell frequency.

It is mainly used to release mechanical brake in elevators after operating at dwell frequency.

Rated frequency = 60Hz

Rated RPM = 1740rpm

Number of motor poles= 4

$$f_{\tau} = 60 - \frac{1740 \times 4}{120} = 2 \text{ Hz}$$



## 10.6 Slip compensation

Group	LED Display	Parameter Name	Set value	Min/Max Range	Factory Defaults	Unit
Function group 2	H30	[Motor type select]	-	0.2/2.2	-	
	H31	[Number of motor poles]	-	2/12	4	
	H32	[Rated slip frequency]	-	0/10	-	Hz
	H33	[Motor rated current]	-	1.0/12	-	A
	H34	[Motor No Load Current]	-	0.1/12	-	A
	H36	[Motor efficiency]	-	50/100	-	%
	H37	[Load inertia rate]	-	0/2	0	
	H40	[Control mode select]	1	0/3	0	

Set H40 – [Control mode select] to 1 {Slip compensation}.

This function enables the motor to run in constant speed by compensating inherent slip in an induction motor. If motor shaft speed decreases significantly under heavy loads then this value should be increased.

H30 : Set the motor type connected to the inverter.

H30	[Motor type select]	0.2	0.2kW
		0.4	0.4kW
		0.75	0.75kW
		1.5	1.5kW
		2.2	2.2kW

H31 : Enter the pole number on the Motor nameplate.

## 10.7 PID Control

Group	LED Display	Parameter Name	Set value	Min/Max Range	Factory Defaults	Unit
Function group 2	H40	[Control mode select]	2	0/3	0	-
	H50	[PID Feedback select]	-	0/1	0	-
	H51	[P gain for PID controller]	-	0/999.9	300.0	%
	H52	[Integral time for PID controller (I gain)]	-	0.1/32.0	300	Sec
	H53	[Differential time for PID controller (D gain)]	-	0.0/30.0	0	Sec
	H5	[F gain for PID controller]	-	0/999.9	0	%
	H5	[PID output frequency limit]	-	0/400	60.0	Hz
	I20~24	Multi-function input terminal P1-P5 define	21	0/24	-	-

Set H40 to 2 {PID Feedback control}.

**Output frequency of the inverter is controlled by PID control for use as constant control of flow, pressure or temperature**

### 10.8 Auto tuning

Group	LED Display	Parameter Name	Set value	Min/Max Range	Factory Defaults	Unit
Function group 2	H41	[Auto tuning]	1	0/1	0	-
	H4	[Stator resistance (Rs)]	-	0/14.0	-	$\Omega$
	H4	[Leakage inductance (L $\sigma$ )]	-	0/300.00	-	mH

Automatic measuring of the motor parameters is provided.

### The measured motor parameters in H41 can be used in Auto Torque Boost and Sensorless Vector Control

H41 : When H41 is set to 1 and press the Prog/Ent (-) key, Auto tuning is activated and "TUn" will appear on the LED keypad. When finished, "H41" will be displayed.

H42, H44 : The values of motor stator resistance and leakage inductance detected in H41 are displayed, respectively. When H93 – [Parameter initialize] is done, the preset value corresponding to motor type (H30) will be displayed.

Press the STOP/RST key on the keypad or turn on the BX terminal to stop the Auto Tuning.

If Auto tuning of H42 and H44 is interrupted, the preset value will be used.

See page 10-12 for motor preset parameter values

#### 10.9 Sensorless vector control

Group	LED Display	Parameter Name	Set value	Min/Max Range	Factory Defaults	Unit
Function group 2	H40	[Control mode select]	3	0/3	0	-
	H30	[Motor type select]	-	0.2/2.2	-	kW
	H32	[Rated slip frequency]	-	0/10	-	H Z
	H33	[Motor rated current]	-	1.0/12	-	A
	H34	[Motor No Load Current]	-	0.1/12	-	A
	H42	[Stator resistance (Rs)]	-	0/14.0	-	Ω
	H44	[Leakage inductance (Lσ)]	-	0/300.00	-	mH
	F14	[Time for energizing a motor]	-	0.0/60.0	1.0	Sec

If H40 – [Control mode select] is set to 3, Sensorless vector control will become active.

#### Caution :

Motor parameters should be measured for high performance. It is highly recommended H41 – [Auto tuning] be done prior to proceeding operation via Sensorless vector control.

#### 10.10 Energy-saving operation

Group	LED Display	Parameter Name	Set value	Min/Max Range	Factory Defaults	Unit
Function group 1	F40	[Energy-saving level]	-	0/30	0	%

Set the amount of output voltage to be reduced in F40.

Set as the percent of Max output voltage.

For fan or pump applications, energy consumption can be dramatically reduced by decreasing the output voltage when light or no load is connected.

### 10.11 Speed Search

Group	LED Display	Parameter Name	Set value	Min/Max Range	Factory Defaults	Unit
Function group 2	H22	[Speed Search Select]	-	0/15	0	
	H23	[Current level during Speed search]	-	80/200	100	%
	H24	[Pgain during Speed search]	-	0/9999	100	
	H25	[I gain during speed search]	-		1000	
I/O group	I54	[Multi-function output terminal select]	15	0/20	12	
	I55	[Multi-function relay select]	15		17	

This is used to prevent possible fault from occurring if the inverter outputs the output voltage during operation after the load is removed.

**The inverter estimates the motor rpm based on output current, so detecting exact speed is difficult**

The following table shows 4 types of Speed search selection.

H22	[Speed search select]		Speed search during H20 – [Power ON start]	Speed search during Instant Power Failure restart	Speed search during H21- [Restart after fault reset]	Speed search during Acceleration
			Bit 3	Bit 2	Bit 1	Bit 0
		0	-	-	-	-
		1	-	-	-	
		2	-	-		-
		3	-	-		
		4	-		-	-
		5	-		-	
		6	-			-
		7	-			
		8		-	-	-
		9		-	-	
		10		-		-
		11		-		
		12			-	-
		13			-	
		14				-
		15				

H23 : It limits the current during Speed search. Set as the percent of H33 – [Motor rated current].

H24, H25 : Speed search is activated via PI control. Adjust P gain and I gain corresponding to the load characteristics.

I54, I55 : Signal of active Speed search is given to external sequence via Multi-function output

terminal(MO) and Multi-function relay output (30AC).



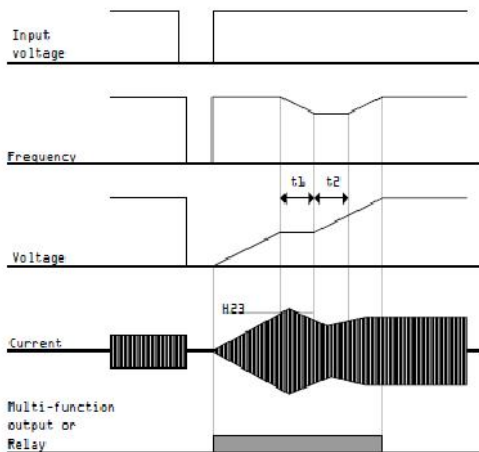

### 10.12 Auto restart try

Group	LED Display	Parameter Name	Set value	Min/Max Range	Factory Defaults	Unit
Function group 2	H26	[Number of Auto Restart try]	-	0/10	0	
	H27	[Auto Restart time]	-	0/60	1.0	Sec

This parameter sets the number of times auto restart is activated in H26.

It is used to prevent the system down caused by internal protection function activated by the causes such as noise.

Group	LED Display	Parameter Name	Set value	Min/Max Range	Factory Defaults	Unit
Function group 2	H39	[Carrier frequency select]	-	0/15	10	

H39	If carrier frequency set higher	Motor noise	
		Heat loss of the inverter	
		Inverter noise	
		Leakage current	

### 10.13 Second motor operation

Group	LED Display	Parameter Name	Set value	Min/Max Range	Factory Defaults	Unit
Function group 2	H81	[2 <sup>nd</sup> motor <sup>nd</sup> Accel time]	-	0/6000	5.0	Sec
	H82	[2 <sup>nd</sup> motor <sup>nd</sup> Decel time]	-		10.0	Sec
	H83	[2 <sup>nd</sup> motor <sup>nd</sup> base frequency]	-	30/400	60.0	Hz
	H84	[2 <sup>nd</sup> motor <sup>nd</sup> V/F pattern]	-	0/2	0	
	H85	[2 <sup>nd</sup> motor forward torque boost]	-	0/15	5	%
	H86	[2 <sup>nd</sup> motor reverse torque boost]	-		5	%
	H87	[2 <sup>nd</sup> motor stall prevention level]	-	30/200	150	%
	H88	[2 <sup>nd</sup> motor Electronic thermal level for 1 min]	-	50/200	150	%
	H89	[2 <sup>nd</sup> motor Electronic thermal level for continuous]	-		100	%
	H90	[2 <sup>nd</sup> motor <sup>nd</sup> rated current]	-	0.1/20	1.8	A
I/O group	I20	[Multi-function input terminal P1 define]	-	0/24	0	
	~	~				
	I24	[Multi-function input terminal P5 define]	12		4	

**Select the terminal among Multi-function input P1 thru P5 for second motor operation.**

If using the terminal P5 for second motor operation, set I24 to 12.

Used when an inverter operates 2 motors connected to two different types of the loads.

**2<sup>nd</sup> motor operation does not run 2 motors at the same time.** As the figure below, when using two motors with an inverter by exchanging them, different values can be set for the 2<sup>nd</sup> motor via the Multi-function input terminal and parameters set in H81-H90.

**Turn the I24(setting: 12) On after motor is stopped.**

Parameters from H81 to H90 are applied to the 1<sup>st</sup> motor as well as the 2<sup>nd</sup> motor.

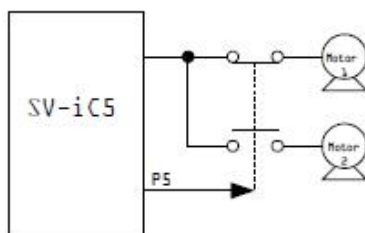

10.14 Parameter initialize & Lock

Parameter initialize

Group	LED Display	Parameter Name	Min/Max Range		Factory Default
Function group 2	H93	[Parameter initialize]	0	-	0
			1	Initialize all 4 parameter groups	
			2	Initialize Drive group Only	
			3	Initialize Function group 1 Only	
			4	Initialize Function group 2 Only	
			5	Initialize I/O group Only	

Select the group to be initialized and initialize the parameters in H93.

### Password Register

Group	LED Display	Parameter Name	Set value	Min/Max Range	Factory Defaults	Unit
Function group 2	H94	[Password Register]	-	0/FFF	0	
	H95	[Parameter lock]	-	0/FFF	0	

This parameter creates password for H95 – [Parameter lock].

Valid password is Hexa decimal value (0-9, A, B, C, D, E, F).

Factory default password is 0. Enter the new password except 0.

Follow the table below to register password for Parameter lock.

Step	Description	LED Display
1	Jump to H94 – [Password Register].	H94
2	Press the Prog/Ent ( ) key twice.	0
3	Enter the password you wish (e.g.: 123).	123
4	“123” is blinking by pressing the Prog/Ent ( ) key.	123
4	Press the Prog/Ent ( ) key once to enter the value into memory.	H94

Follow the table below to change the password. (Current PW: 123 -> New PW: 456)

Step	Description	LED Display
1	Jump to H94 – [Password Register].	H94
2	Press the Prog/Ent ( ) key once.	0
3	Enter any number (e.g.: 122)	122

4	Press the Prog/Ent ( ) key. 0 is displayed because wrong value was entered. Password cannot be changed in this status.	0
5	Enter the right password.	123
6	Press the Prog/Ent ( ) key once.	123
7	Enter a new password.	456
8	Press the Prog/Ent ( ) key. Then "456" will blink.	456
9	Enter the Prog/Ent ( ) key to finish.	H94

### Parameter Lock

Group	LED Display	Parameter Name	Set value	Min/Max Range	Factory Defaults	Unit
Function	H95	[Parameter lock]	-	0/FFF	0	
group 2	H94	[Password Register]	-	0/FFF	0	

This parameter is used to lock the user-set parameters using the password.

Step	D	LED Display
1	Go to H95 – [Parameter lock]	H95
2	Enter the Prog/Ent ( ) key	UL
3	Parameter value can be changed in UL (Unlock) status. While seeing this	UL
4	Enter the Prog/Ent ( ) key.	0
5	Enter the password created in H94 (e.g.: 123).	123
6	Enter the Prog/Ent ( ) key	L
7	Parameter value cannot be changed in L (Lock) status.	L
8	Press either the left ( ) or right ( ) key.	H95

See the table below to unlock the user-set parameter via password.

Step		LED Display
1	Go to H94 – [Password register]	H94
2	Press the Prog/Ent ( ) key	L
3	Parameter value cannot be changed in L(Lock) status.	L
4	Press the Prog/Ent ( ) key	0
5	Enter the password created in H94 (e.g.: 123).	123
6	Press the Prog/Ent ( ) key	UL
7	Parameter value can be changed in UL (Unlock) status. While seeing this message...	UL
8	Press the Prog/Ent ( ) key	H95

## 11. Monitoring

### 11.1 Operating status monitoring

#### Output current

Group	LED Display	Description	Set value	Min/Max range	Factory default	Unit
Drive group	CUr	Output current	-			

Inverter output current can be monitored in Cur.

#### Motor RPM

Group	LED Display	Description	Set value	Min/Max range	Factory default	Unit
Drive group	rPM	[Motor RPM]	-			
Function group 2	H31	[Number of motor poles]	-	2/12	4	
	H40	[Control mode select]	-	0/2	0	
	H74	[Gain for Motor rpm display]	-	1/1000	100	%

Motor rpm can be monitored in rPM.

When H40 is set to 0 {V/F control} or 1 {PID control}, the Inverter output frequency (f) is displayed in

RPM using the formula below. Motor slip is not considered.

$$RPM = \frac{120 \times f}{H31} \times \frac{H74}{100}$$

H31 : Enter the number of rated motor poles on the nameplate.

H74 : This parameter is used to change the motor speed display to rotating speed

(r/min) or mechanical speed (m/mi).

Inverter DC Link Voltage

Group	LED Display	Parameter Name	Set value	Min/Max range	Factory default	Unit
Drive group	dCL	[Inverter DC Link Voltage]	-			

Inverter DC link voltage can be monitored in dCL.

times the value of input voltage is displayed while motor is at a stop.

It is the voltage detected between P1 and N terminal of power terminal.

User display select

Group	LED Display	Parameter Name	Set value	Min/Max range	Factory default	Unit
Drive group	vOL	[User display select]	-			
Function group 2	H73	[Monitoring item select]	-	0/2	0	

The selected item in H73- [Monitoring item select] can be monitored in vOL- [User display select].

H73 : Select one of the desired item numbers

H73	[Monitoring item select]	0	Output voltage [V]	
		1	Output power [kW]	
		2	Torque	

Enter motor efficiency indicated on motor nameplate to H36 to display correct torque

Power on display

Group	LED display	Parameter Name	Setting		Factory default
Function group 2	H72	[Power on display]	0	Frequency command (0.0)	0
			1	Accel time (ACC)	
			2	Decel time (DEC)	
			3	Drive mode (drv)	
			4	Frequency mode (Frq)	
			5	Multi-step frequency 1	
			6	Multi-step frequency 2	
			7	Multi-step frequency 3	
			8	Output current (CUr)	
			9	Motor rpm (rPM)	
			10	Inverter DC link voltage (dCL)	
			11	User display select (vOL)	
			12	Fault display 1	
		13	Fault display 2		

Select the parameter to be displayed on the keypad when the input power is first applied.



## 11.2 Monitoring the I/O terminal

### Input terminal status monitoring

Group	LED Display	Parameter Name	Set value	Min/Max range	Factory default	Unit
I/O group	I25	[Input terminal status display]	-			

Active input terminal status (ON/OFF) can be monitored in I25

The following is displayed when P1, P3, P4 are ON and P2, P5 are OFF

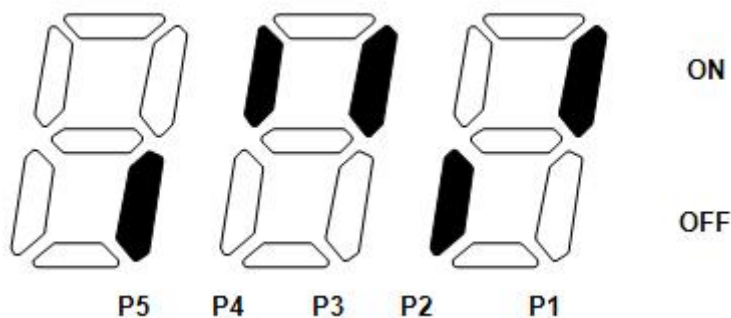

### Output terminal status monitoring

Group	LED Display	Parameter Name	Set value	Min/Max range	Factory default	Unit
I/O group	I26	[Output terminal status display]	-			

Current status (ON/OFF) of the Multi-function output terminal (MO) and Multi-function relay can be monitored in I26.

The following is displayed when Multi-function output terminal (MO) is ON and Multi-function relay

(30AC) is OFF.

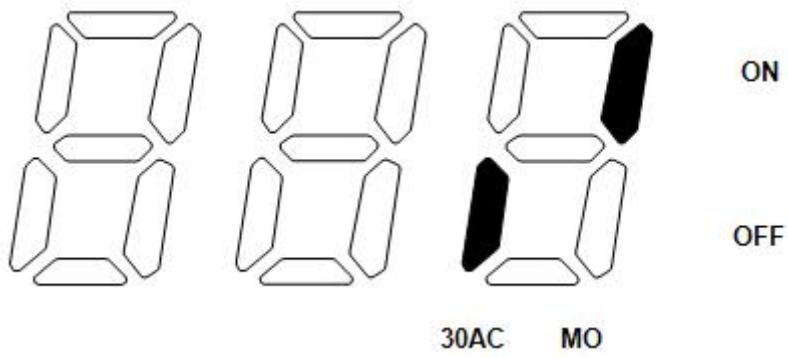

### 11.3 Monitoring fault condition

#### Monitoring fault display

Group	LED Display	Parameter Name	Set value	Min/Max range	Factory default	Unit
Drive group	nOn	[Fault Display]	-			

The kind of fault occurred during operation is displayed in nOn.

Up to 3 kinds of faults can be monitored.

This parameter gives information on fault types and the operating status at the time of the fault. Refer to 1.6 How to monitor operation

Refer to Page 13-1 for various fault types.

Fault types	Frequency		
	Current		
	Accel/Decel Information		Fault during Accel

			Fault during Decel
			Fault during constant run

### Fault History Monitoring

Group	LED Display	Parameter Name	Set value	Min/Max range	Factory default	Unit
I/O group	H 1	[Fault history 1]	-			
	~	~				
	H 5	[Fault history 5]				
	H 6	[Reset fault history]	-	0/1	0	

H 1 ~ H 5 : Up to 5 fault information is stored

H 6 : Previous fault information stored in the code H1 thru H5 is all cleared.

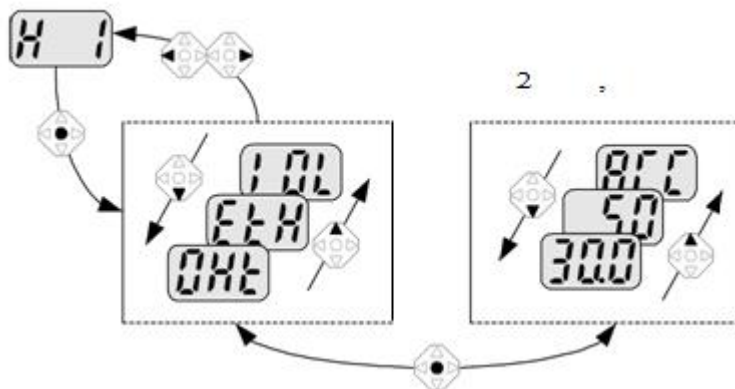

### 11.4 Analog Output

Group	LED Display	Parameter Name	Set value	Min/Max range	Factory default	Unit
I/O group	I50	[Analog output item select]	-	0/3	0	
	I51	[Analog output level adjustment]	-	10/200	100	%

Output item and the level from the AM terminal are selectable and adjustable.

I50 : The selected item will be output to Analog output terminal (AM)

I50	Analog output item select			10V
		0	Output frequency.	Max Frequency (F21)
		1	Output current	150% of Inverter rated current
		2	Output voltage	282 Vac
		3	Inverter DC link voltage	400 Vdc

I51 : If you want to use Analog output value as a gauge input , the value can be adjustable

corresponding to various gauge specifications.

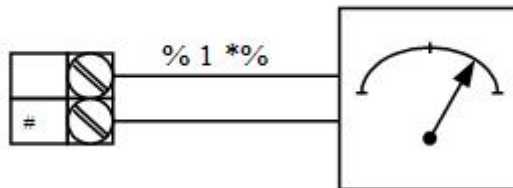

### 11.5 Multi-function output terminal (MO) and Relay (30AC)

Group	LED display	Parameter Name	Setting			Factory default		
I/O group	I54	[Multi-function output terminal select]	0	FDT-1			12	
			1	FDT-2				
	I55	[Multi-function relay select]	2	FDT-3				
			3	FDT-4				
			4	FDT-5				
			5	Overload {OL}				
			6	Inverter Overload {IOL}				
			7	Motor stall {STALL}				
			8	Over voltage trip {OV}				
			9	Low voltage trip {LV}				
			10	Inverter cooling fan overheat {OH}				
			11	Command loss				
			12	During run				
			13	During stop				
			14	During constant run				
			15	During speed searching				
			16	Wait time for run signal input				
			17	Fault relay output				
		I56	[Fault relay output]	When setting the H26-[Number of auto restart tries]	When the trip other than	When the low voltage trip		
				Bit 2	Bit 1	Bit 0		
			0	-	-	-		

			1	-	-	
			2	-		-
			3	-		
			4		-	-
			5		-	
			6			-
			7			

Select the desired item to be output via MO terminal and relay (30AC).

I56 : When 17 {Fault display} is selected in I54 and I55, Multi-function output terminal and relay will be activated with the value set in I56.

0 : FDT-1

Group	LED Display	Parameter Name	Set value	Min/Max range	Factory default	Unit
I/O group	I53	[Frequency Detection Bandwidth]	-	0/400	10.0	Hz

Cannot be set above Max frequency (F21).

When setting I53 to 10.0

1 :

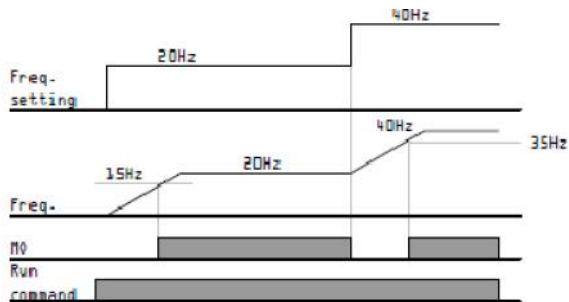

## FDT-2

It activates when the preset frequency matches frequency detection level (I52) and FDT-1 condition is met.

Active condition: (Preset frequency = FDT level) & FDT-1

Group	LED Display	Parameter Name	Set value	Min/Max range	Factory default	Unit
I/O group	I52	[Frequency Detection	-	0/400	30.0	Hz
	I53	[Frequency detection	-		10.0	

It cannot be set above F21- [Max frequency].

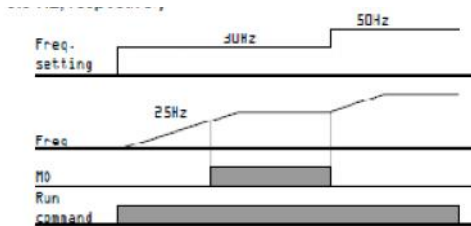

## 2 : FDT-3

It activates when run frequency meets the following condition

Active condition: Absolute value (FDT level - run frequency)  $\leq$  FDT Bandwidth/2

Group	LED Display	Parameter Name	Set value	Min/Max range	Factory default	Unit
I/O group	I52	[Frequency Detection	-	0/400	30.0	Hz
	I53	[Frequency Detection	-		10.0	

It cannot be set above F21- [Max frequency]

When setting I52 and I53 to 30.0Hz and 10.0 Hz, respectively

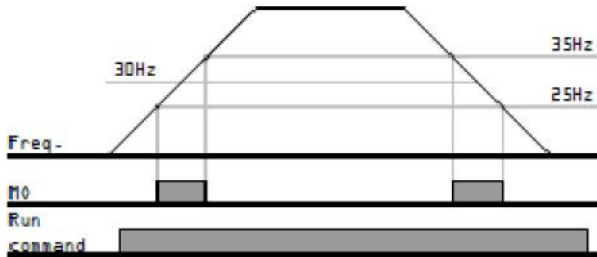

3 : FDT-4

Become active when run frequency meets the following condition.

Active condition

Accel time: Run Frequency  $\geq$  FDT Level

Decel time: Run Frequency  $>$  (FDT Level – FDT Bandwidth/2)

Group	LED Display	Description	Set value	Min/Max range	Factory default	Unit
I/O group	I52	[Frequency Detection level]	-	0/400	30.0	Hz
	I53	[Frequency Detection]	-		10.0	

Cannot be set above F21- [Max Frequency].

When setting I52, I53 to 30.0 Hz and 10.0Hz, respectively.

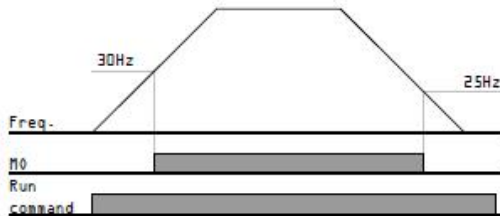



#### 4 : FDT-5

Activates at B contact.

Active condition

Accel time: Run Frequency  $\geq$  FDT Level

Decel time: Run Frequency  $>$  (FDT Level – FDT Bandwidth/2)

Group	LED Display	Parameter Name	Set value	Min/Max range	Factory default	Unit
I/O group	I52	[Frequency Detection	-	0/400	30.0	Hz
	I53	[Frequency Detection	-		10.0	

It cannot be set above F21- [Max Frequency].

When setting I52, I53 to 30.0 Hz and 10.0Hz, respectively

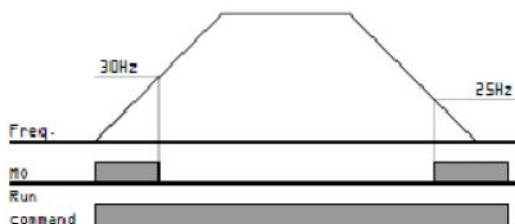

#### 5 : Overload{OL}

Refer to Page 12-2 Overload Warning and trip

#### 6 : Inverter Overload{IOL}

Refer to Page 12-6 Inverter Overload

#### 7 : Motor Stall {STALL}

Refer to Page 12-3 Stall prevention

8 : Over voltage Trip {Ovt}

Become active when DC link voltage exceeded 400V and led to Over voltage trip

9 : Low voltage Trip {Lvt}

Become active when DC link voltage decreased to 200V and led to Low voltage trip

10 : Inverter cooling fin overheating {Oht}

Become active when overheated inverter cooling fan triggers protection function.

11 : Command Loss

Become active when frequency command is lost.

12 : During run

Become active when run command is given and the inverter generates output voltage.

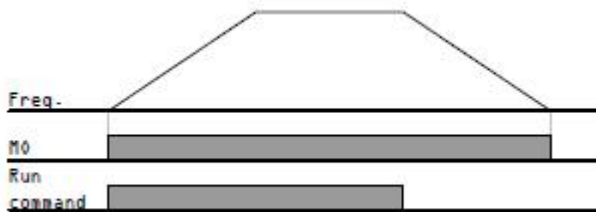

13 : During stop

Activated during stop.

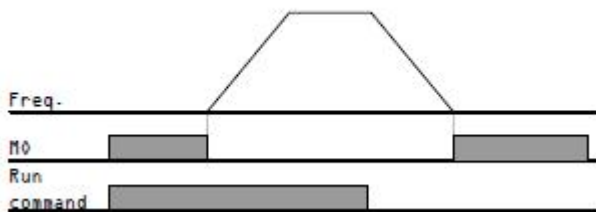

14 : During constant run

Activated during nominal operation

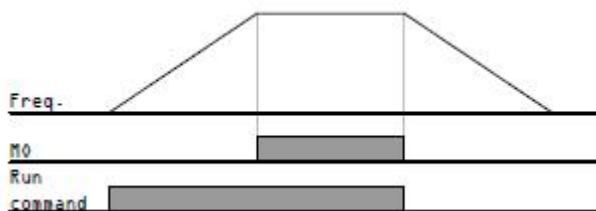

15 : During speed searching

Refer to Page 10-12 Speed search operation

16 : Wait time for run signal input

This function becomes active during normal operation and that the inverter waits for active run command from external sequence.

17 : Fault relay output

The parameter set in I56 is activated.

For example, if setting I55, I56 to 17 and 2, respectively, Multi-function output relay will become active when trip other than “Low voltage trip” occurred.

## 12. Protective functions

### 12.1 Electronic Thermal

Group	LED display	Parameter Name	Set value	Min/Max setting	Factory default	Unit
Function group 1	F50	[Electronic thermal select]	1	0/1	0	
	F51	[Electronic thermal level for 1 minute]	-	50/150	150	%
	F52	[Electronic thermal level for continuous]	-		100	%
	F53	[Motor type]	-	0/1	0	

Select F50 – [Electronic thermal select] to 1.

It activates when the motor is overheated (time-inverse). If current greater than set in F51 flows, inverter output is turned off for the preset time in F51- [Electronic thermal level for 1 minute].

F51 : Enter the value of max current that is capable of flowing to the motor continuously for one minute. It is set in percent of motor rated current. The value cannot be set lower than F52.

F52 : Enter the amount of current for continuous operation. Normally motor rated current is used. It cannot be set greater than F51.

F53 : For an inductance motor, cooling effects decrease when a motor is running at low speed. A

special motor is a motor that uses a separately powered cooling fan maximize cooling effect even in low speed. Therefore, as the motor speed changes, the cooling do not change.

F53	[Motor type]	0	Standard motors having a cooling fan directly connected to the shaft
		1	Special motor that uses a separately powered cooling fan.

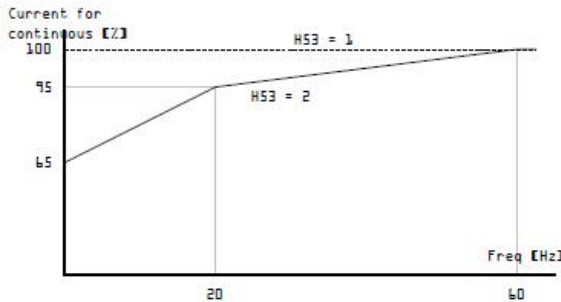

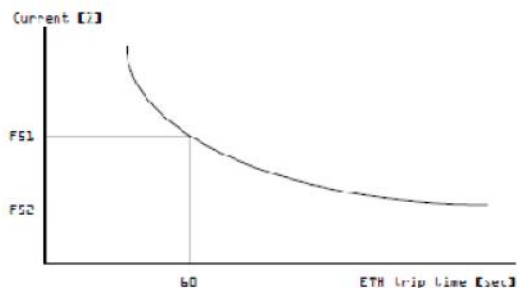

## 12.2 Overload Warning and trip

### Overload warning

Group	LED Display	Parameter Name	Set value	Min/Max setting	Factory default	Unit
Function group 1	F54	[Overload warning level]	-	30/150	150	%
	F55	[Overload warning time]	-	0/30	10	Sec
I/O group	I54	[Multi-function output]	5	0/17	12	
	I55	[Multi-function relay select]	5		17	

Select one output terminal for this function between MO and 30AC.

If selecting MO as output terminal, set I54 to 5 {Overload : OL}.

F54 : Set the value as a percent of motor rated current



## Overload trip

Group	LED Display	Parameter Name	Set value	Min/Max setting	Factory default	Unit
Function group 1	F56	[Overload trip select]	1	0/1	0	
	F57	[Overload trip level]	-	30/200	180	%
	F58	[Overload trip time]	-	0/60	60	sec

Set F56 to 1.

Inverter output is turned off when motor is overloaded.

Inverter output is turned off when excessive current flows to the motor for F58 – [Overload trip time].

### 12.3 Stall prevention

Group	LED Display	Parameter Name	Set value	Min/Max setting	Factory default	Unit
Function group 1	F59	[Stall prevention select]	-	0/7	3	
	F60	[Stall prevention level]	-	30/150	150	%
I/O group	I54	[Multi-function output terminal select]	7	0/17	12	
	I55	[Multi-function relay select]	7		17	

During acceleration : Motor acceleration is stopped when current exceeding the value set in F60 flows.

During constant run : Motor decelerates when current exceeding the value set in F60 flows.

During deceleration : Motor deceleration is stopped when inverter DC link voltage rises above a certain voltage level

F60 : The value is set as the percent of motor rated current (H33).

I54, I55: Inverter outputs signals through multi-function output terminal (MO) or relay output (30AC) when stall prevention function is activated. Stall prevention operation can be monitored by external sequence

F59 : Stall prevention can be set as the table below

F59	[Stall prevention select]	Setting	During Deceleration	During constant speed	During Acceleration
			Bit 2	Bit 1	Bit 0
		0	-	-	-
		1	-	-	
		2	-		-
		3	-		
		4		-	-
		5		-	
		6			-
		7			

For example, set F59 to 3 to make stall prevention active during Acceleration and constant run.

When stall prevention is executed during acceleration or deceleration, Accel/Decel time may take longer than the user-setting time.

When stall prevention is activated during constant run, t1, t2 executed in accordance with the value set in ACC - [Accel time] and dEC - [Decel time].

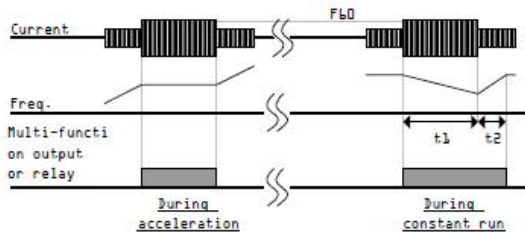

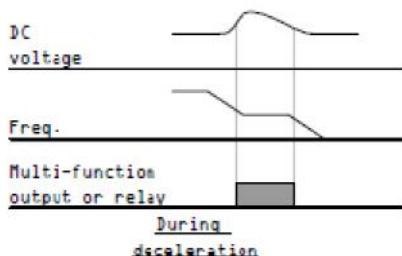

#### 12.4 Output phase loss protection

Group	LED display	Parameter Name	Set value	Min/Max setting	Factory default	Unit
Function group 2	H19	[Output phase loss protection select]	1	0/1	0	

Set H19 value to 1.

This function turns off the inverter output in the event of more than one phase loss

among U, V and W output

**Caution :**

Set H33- [Motor rated current] correctly. If the actual motor rated current and the value of H33 are different, this function could not be activated.

#### 12.5 External trip signal

Group	LED display	Description	Set Value	Min/Max setting	Factory default	Unit
I/O group	I20	[Multi-function input terminal P1 define]		0/24	0	
	~	~				
	I23	[Multi-function input]	18		3	
	I24	[Multi-function input]	19		4	



**Select a terminal among P1 thru P5 to output external trip signal.**

Set I23 and I24 to 18 and 19 to define P4 and P5 as External A contact and B contact.

External trip signal input A contact (N.O) : This is a normally open contact input. When a P4 terminal set to "Ext trip-A" is ON, inverter displays the fault and turns off its output.

External trip signal input B contact (N.C) : This is a normally closed contact input. When a terminal set to "Ext trip-B" is OFF, inverter displays the fault and turns off its output.

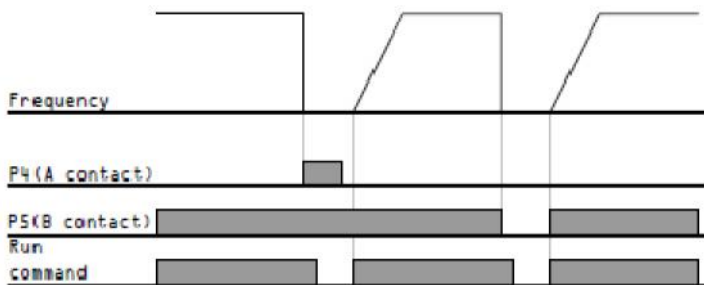
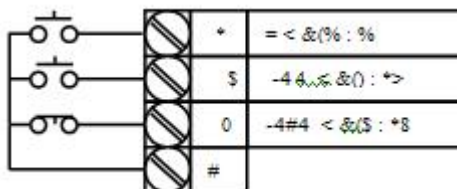

12.6 Inverter Overload

Inverter overload prevention function is activated when the current above inverter rated current flows.

Multi-function output terminal (MO) or Multi-function relay (30AC) is used as the alarm signal output during inverter overload trip.

Group	LED display	Parameter Name	Set value	Min/Max Range	Factory default	Unit
I/O group	I54	[Multi-function output	7	0/17	12	
	I55	[Multi-function relay select]	7		17	

## 12.7 Frequency command loss

Group	LED display	Parameter Name	Set value	Min/Max setting	Factory default	Unit
I/O group	I16	[Criteria for analog input signal loss]	0	0/2	0	
	I62	[Drive mode select after of loss frequency command]	-	0/2	0	
	I63	[Wait time after loss of frequency command]	-	1/12 0/17	1.0	Sec
	I54	[Multi-function output	11		12	
	I55	[Multi-function relay select]	11	17		

I16 : This is to set the criteria for analog input signal loss when frequency reference is given by V1, I,

V1+I or Communication option.

I16	[Criteria for analog input signal loss]	0	Disabled (Does not check the analog input signal loss)
		1	When less than the value set in I 2, I 7, I 12 is entered
		2	When below the value set in I 2, I 7, I 12 is entered

EX 1) The inverter determines that the freq reference is lost when DRV- Frq is set to 3 (Analog V1 input), I 16 to 1 and analog input signal is less than

half of the minimum value set in I 7.

EX 2) The inverter determines that the freq reference is lost when DRV- Frq is set to 6 (V1+), I 16 to 2 and V1 input signal is either below the minimum value set in I 7 or I input value is less than the I 12 value.

I62 : When no frequency command is given for the time set in I63, set the drive mode as the table below.

I62	[Drive mode select after loss of frequency command]	0	Continuous operation with the frequency before command loss occurs
		1	Free run stop (output cut off)
		2	Decel to stop

I54, I55 : Multi-function output terminal (MO) or Multi-function relay output (30AC) is used to output information on loss of frequency command to external sequence.

For example, when I62 is set to 2, I63 to 5.0 sec and I54 to 11, respectively,

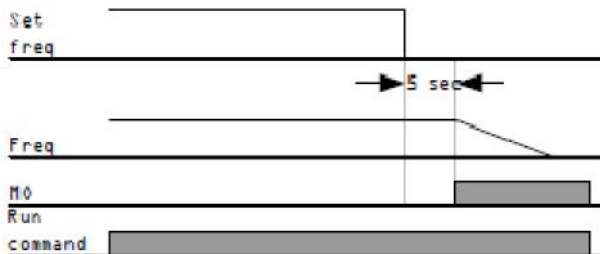

### روش‌های کنترل سرعت توسط "اینورتر"

با توجه به تنوع حالات کاری و همچنین ورودی‌های فرمان دستگاه، روش‌های متنوعی جهت کنترل حرکت الکتروموتور قابل اجرا می‌باشد. از جمله :

قبل از راه اندازی برای بار اول باید پارامترهای زیر تنظیم گردند: 

نام پارامتر	کاربرد	مقدار تنظیمی
ACC	تعیین مدت زمان افزایش سرعت تا مقدار تنظیم شده	دلخواه
DEC	تعیین مدت زمان کاهش سرعت تا صفر	دلخواه
F4	تعیین مدت توقف	با توجه به جدول پارامترها
F21	تعیین ماکزیمم فرکانس	کمتر از ۴۰۰ هرتز
F22	تعیین فرکانس پایه	با توجه به نوع موتور (معمولاً ۵۰ هرتز)
F23	تعیین مینیمم فرکانس	دلخواه و بیشتر از ۰/۱ هرتز
F57	تعیین درصد خطای اضافه جریان	دلخواه
H33	تعیین مقدار جریان موتور	دلخواه

۱- تنظیم جهت حرکت، فرمان چرخش به همراه کنترل سرعت توسط صفحه کلید تنظیم پارامترها :

نام پارامتر	مقدار تنظیمی
Drv	صفر
Frq	صفر
Drc	r یا F

فرمان ها:

کلید های **STOP** و **RUN** جهت راه اندازی و توقف

۲- حرکت توسط ورودی های **Rx** یا **Fx** و کنترل سرعت توسط ولوم نصب شده بر روی صفحه کلید

#### تنظیم پارامترها

نام پارامتر	مقدار تنظیمی
<b>Drv</b>	۱
<b>Frq</b>	۲

فرمان ها:

ورودی های **Rx** یا **Fx**

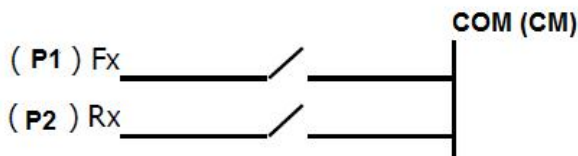

۳- چرخش و تنظیم جهت حرکت توسط صفحه کلید و کنترل سرعت توسط ولوم نصب شده بر روی صفحه کلید

#### تنظیم پارامترها

نام پارامتر	مقدار تنظیمی
<b>Drv</b>	صفر
<b>Frq</b>	۲

فرمان ها:

- کلید های **STOP** و **RUN** جهت راه اندازی و توقف
- چرخاندن ولوم جهت کنترل سرعت

۴- چرخش و تنظیم جهت حرکت توسط صفحه کلید و کنترل سرعت توسط ولوم خارجی یا ولتاژ ۰ تا ۱۰ ولت آنالوگ

#### تنظیم پارامترها

نام پارامتر	مقدار تنظیمی
Drv	صفر
Frq	۳

فرمان ها:

- کلیدهای RUN و STOP جهت راه اندازی و توقف
- اتصال پتانسیومتر جهت کنترل سرعت

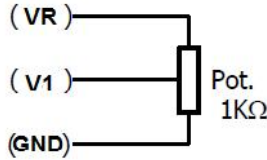

۵- حرکت توسط ورودی‌های RX یا FX و کنترل سرعت توسط ولوم خارجی و یا ورودی ۰ تا ۱۰ ولت آنالوگ

#### تنظیم پارامترها

نام پارامتر	مقدار تنظیمی
Drv	۱
Frq	۳

فرمان ها:

ورودی‌های RX یا FX و اتصال پتانسیومتر

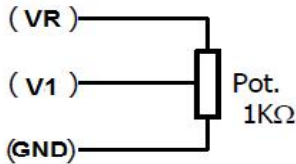

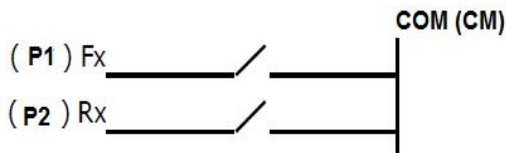

۶- حرکت توسط ورودی‌های Rx یا Fx و کنترل سرعت توسط جریان آنالوگ ورودی ۴ تا ۲۰ میلی آمپر

تنظیم پارامترها

نام پارامتر	مقدار تنظیمی
Drv	۱
Frq	۴

فرمان‌ها:

• ورودی‌های Rx یا Fx و اتصال منبع جریان

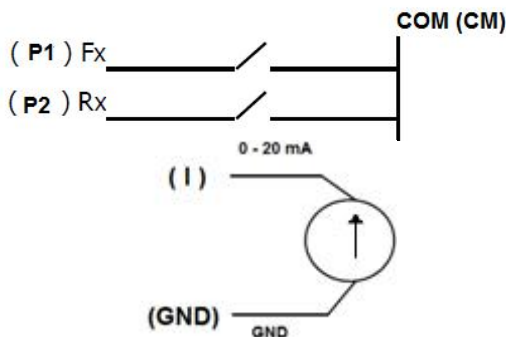

### خطاها

در صورتی که در شرایط کار دستگاه، تغییراتی رخ دهد و وضعیت از حالت نرمال خارج گردد، خروجی دستگاه به صورت خودکار قطع شده و پیغامی با توجه به نوع خطا مبنی بر بروز خطا بر روی صفحه نمایش مشاهده خواهد شد.  
این خطاها به شرح ذیل می باشند :

نوع خطا	حروف اختصاری نمایش داده شده	علت	نحوه رفع
اضافه جریان خروجی	OCUr	کشیده شدن جریان بیش از حد تنظیم شده از "اینورتر"	- زدن کلید OK روی صفحه کلید - قطع اتصال برق ورودی
اضافه ولتاژ در ورودی	OvOL	بالا بودن ولتاژ ورودی از حد مجاز	- زدن کلید OK روی صفحه کلید - قطع اتصال برق ورودی
کاهش ولتاژ در ورودی	UvOL	پایین بودن ولتاژ ورودی از حد مجاز	- زدن کلید OK روی صفحه کلید - قطع اتصال برق ورودی
اشکال در سیستم کنترل "اینورتر"	IGBT	- اتصال فاز های خروجی به یکدیگر - نامناسب بودن سیستم ارت - وجود شوک های شدید جریان در خروجی اینورتر	- زدن کلید OK روی صفحه کلید - قطع اتصال برق ورودی
قطع فاز خروجی	PHAS	قطع بودن یک یا دو فاز خروجی	- زدن کلید OK روی صفحه کلید - قطع اتصال برق ورودی
دمای بیش از حد	OHET	بالا رفتن دمای بیش از حد مجاز	- زدن کلید OK روی صفحه کلید - قطع اتصال برق ورودی

## ترمینال‌ها

ترتیب و محل قرار گرفتن ترمینال‌های بخش قدرت و کنترلی به شرح ذیل می‌باشند

- قدرت: شامل ۵ قسمت مطابق زیر می‌باشند:

U	V	W	ERTH	ورودی AC (L1)	ورودی AC (L2)
---	---	---	------	------------------	------------------

- کنترلی:

شامل قسمت مطابق زیر می‌باشند:



